

ENGINEERING
TOMORROW

Danfoss

User Guide

Capacity controller for CO₂ MiniPack AK-PC 572

ADAP-KOOL® Refrigeration Control System

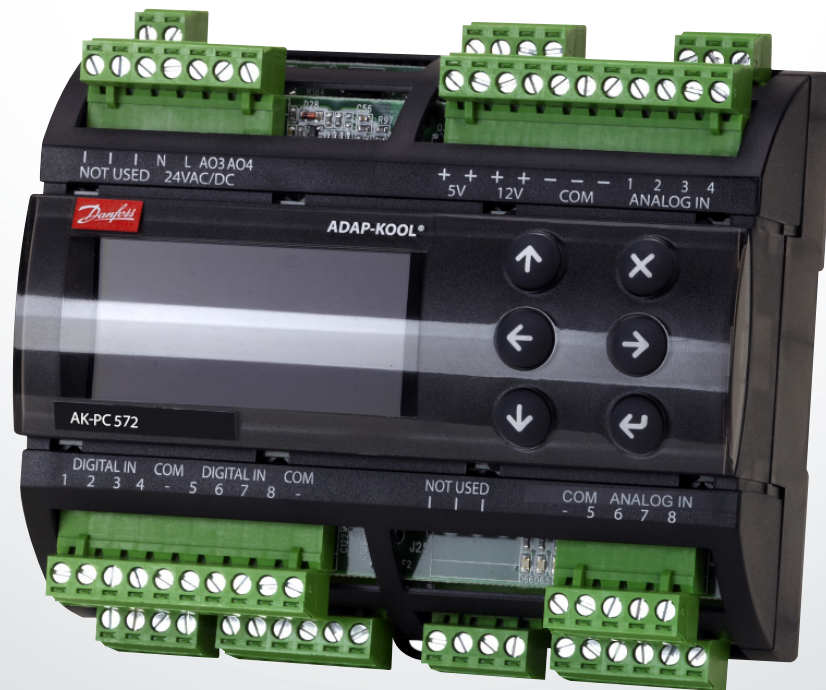

ЮГОВ - Проект
Інженерно-виробниче підприємство

Офіційний дистриб'ютор
Danfoss в Україні



ugov.ua

www.danfoss.com

| | |
|---------------------------------------|----|
| Contents | |
| 1. Introduction | 3 |
| 2. Suction Group | 4 |
| 3. Gas cooler | 5 |
| 4. Receiver control | 6 |
| 5. AUX functions and limitations..... | 7 |
| 6. Safety functions | 8 |
| 7. Display overview | 9 |
| 7.1 End-user overview | 9 |
| 7.2 Set-up overview..... | 10 |
| 8. Menu..... | 11 |
| 9. Alarm list | 22 |
| 10. Important..... | 24 |
| 11. Connections | 26 |
| 12. Data | 30 |
| 13. Mounting/dimensions | 30 |
| 14. Ordering | 31 |

1. Introduction

Application

The controller is used for capacity regulation of compressors and gas cooler in small CO₂ refrigeration applications.

As a minimum, control of a condensing unit can be performed using one compressor unit, one gas cooler and one receiver. A maximum of 3+2 compressors can be regulated. Eg:

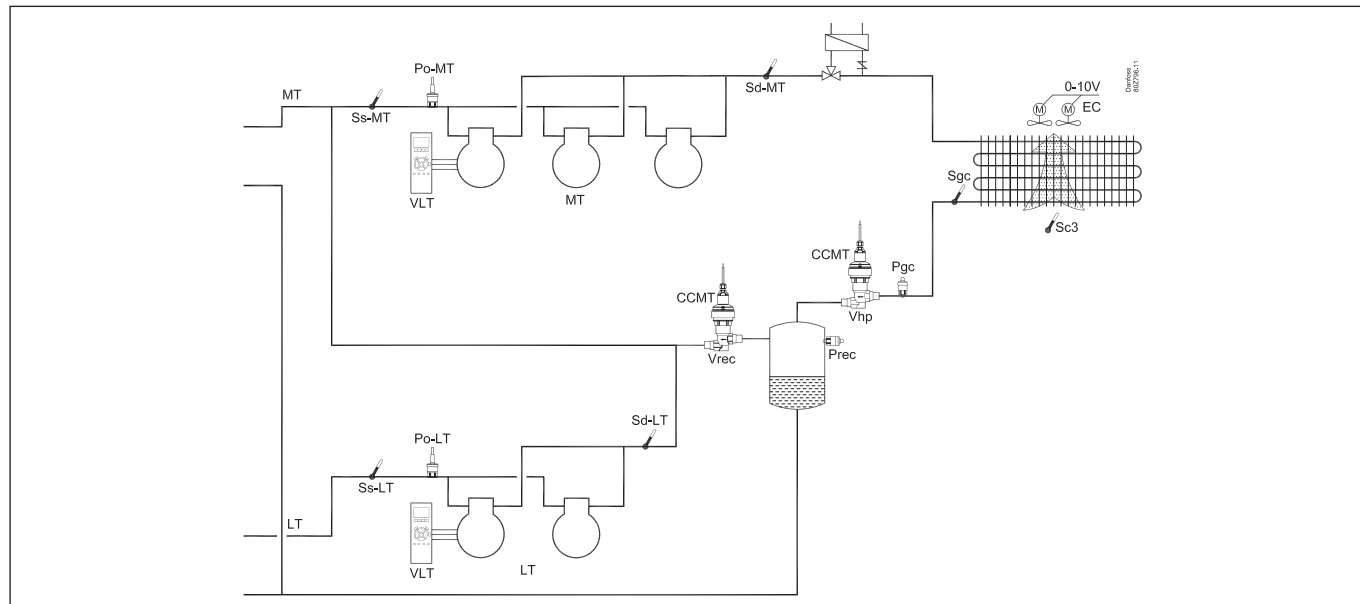

Advantages

- Energy savings via:
 - Optimal control of CO₂
 - Optimisation of suction pressure
 - Night time increase
 - Floating gas cooler reference
 - Heat recovery
 - Load limitation
- Simplified setting of the functions:

The controller ensures that the different control settings are adjusted in accordance with one another. Only basic settings are required.
- Ongoing adjustment of control references:

A newly developed algorithm automatically adapts the controller to actual running conditions and floating set points.
- Easy connection to Bitzer IQ module through Modbus.

Input and output

There are a limited number of available inputs and outputs, so most connections are intended for one specific function. However, there are a few options for AUX use:

- If only one or two compressor units are connected to the MT circuit, there will be a DI input available. This could, for example, be used as an alarm input.
- If the compressor used is not a Bitzer CR11, a solid state output can be used for oil management.
- If heat recovery is not used, the AUX3 function can be used for an alarm function.

In order to control the high pressure valve and receiver pressure valve, two Stepper Valve Extension Modules, EKE 1P, must be connected.

The overview of connections can be seen on page 26.

Operation

The daily operation can be set up directly on the controller or via an external display device.

During set-up, the display images will be adjusted so that only the relevant images are opened for additional setting and end-user operation.

The operation is password protected, and three levels of access can be granted.

The controller contains several languages. Select the preferred language at start-up.

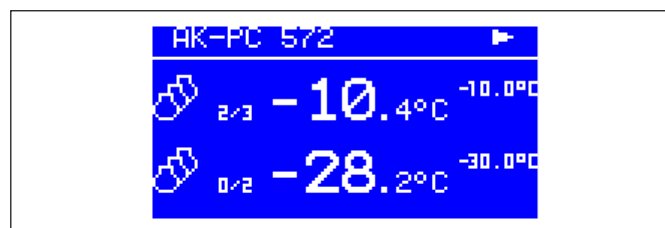

Data communication

The controller has built-in MODBUS data communication, and it can be connected to an AK-SM 800 type system device.

2. Suction Group

Compressor types

The following types of compressors can be used for regulation:

- Single-step compressors
- Variable speed + single step
- Bitzer CR11 compressor with two unloaders (4-cylinders). MT only.
- Bitzer IQ (via MODBUS) + Single step compressors
- CM-RC AO + Single step compressors

Capacity regulation

The cut-in capacity is controlled by signals from the connected pressure transmitter and the actual reference.

In the absence of any reference there is a neutral zone of 5 K.

- When the pressure is higher than the "reference + a half neutral zone", cut-in of the next compressor (arrow up) is permitted.
- When the pressure is lower than the "reference - a half neutral zone", cut-out of a compressor (arrow down) is permitted.
- When the pressure is within the neutral zone, the process will continue with the currently activated compressors.

This is always controlled using the "Best fit" connection pattern.

The reference

The controller will be set based on a fixed reference point.

Based on the configured reference, the controller will permit an offset of up to +/- 8K depending on the other control parameters.

For example:

- Night time increase. Fixed 5 K (on the MT circuit only)
- Po optimisation (on the MT circuit only)

Load shedding

The function is activated from the system unit.

When the load shedding function is activated, the maximum permissible compressor capacity will be limited to 50% of maximum on both MT and LT circuits.

In this way, the total electrical load in the store is limited.

Control parameters

To make it easier to start up the system, the control parameters have been grouped into a number of experience-based values.

These values have been combined in a setting called "Easy-settings". Here you can choose between a set of control settings applicable to a slow to rapidly reacting system.

The factory setting is medium.

Oil management

If the DO6 output is in use by a CR11, oil management cannot take place. If the output is available, the controller can pulse oil into the MT circuit. The time between the pulses can be configured using a timer function or using a signal from a level switch.

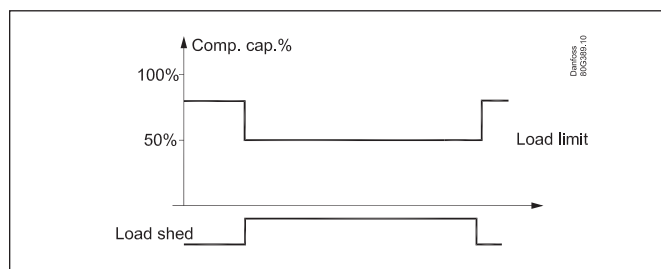
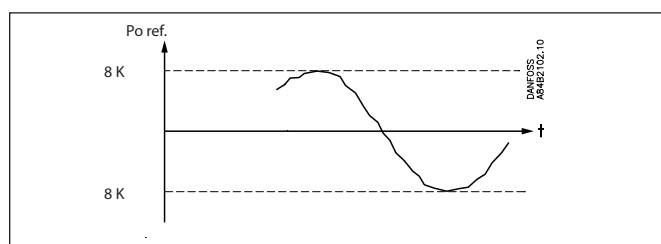
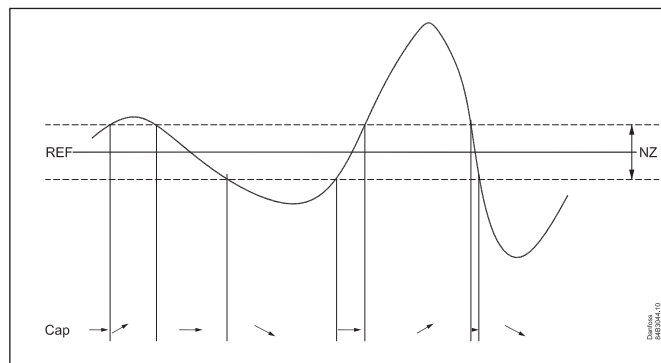

Liquid injection in the MT suction line

This function is possible only if there is an available DO output.

The function opens for liquid when:

- The suction temperature is too high
- The pressurised gas temperature is too high
- Liquid inlet to the compressor must be prevented

De-super heater (DE-SH)

This function is possible only if there is an available DO output.

This function activates a fan so that the pressurised gas temperature in the LT circuit can be lowered:

- The fan stops when the outdoor temperature is low
- The fan stops when the MT superheat is too low

3. Gas cooler

Fan control

The fans must be speed-controlled by the controller's analogue output.

EC motors can receive the 0 – 10 V signal directly.

During night operation, the noise level of the fans can be kept down. This is done by limiting the voltage and thus the speed.

The limitation is bypassed if the safety function Sd max. starts to function.

Regulation

The controller regulates the pressure in the gas cooler (condenser) so that the system achieves the optimal COP.

The pressure in the gas cooler is controlled by the valve Vhp. Regulation must have inputs from both a pressure transmitter Pgc and a temperature sensor Sgc. Both must be fitted in the outlet immediately after the gas cooler.

The valve is an CCMT valve, which has been specially developed for the pressure conditions that exist in a transcritical CO₂ system. The valve's opening degree can be restricted both at the closing point and in the open point.

Maximum COP control

During normal operation without override, the controller will maintain the optimum pressure in the transcritical area.

Reference

It is controlled using variable references.

An outdoor temperature sensor, Sc3, must be installed.

The sensor must be positioned so that it registers the correct outdoor temperature. In other words, it must be shielded from direct sunlight and located near the airway of the condenser.

Under normal operations it will be controlled using a fixed temperature reference of 3 K above the outdoor temperature. The pressure reference will be the configured value for the sub-cooling when adjusting in the sub-critical range, and will be adjusted based on optimal COP when adjusting in the transcritical range.

The reference during heat recovery will be user configured.

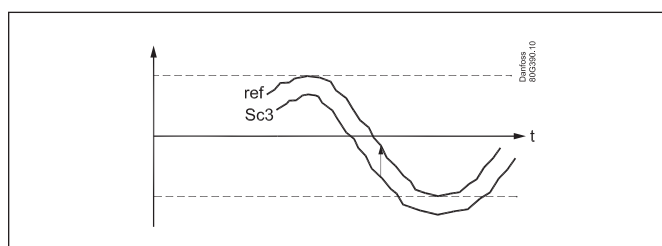
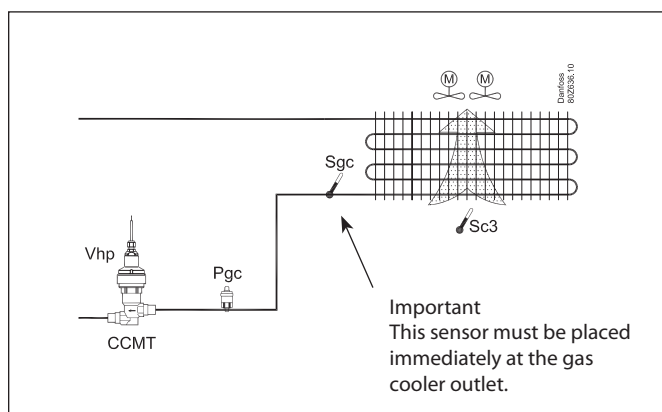
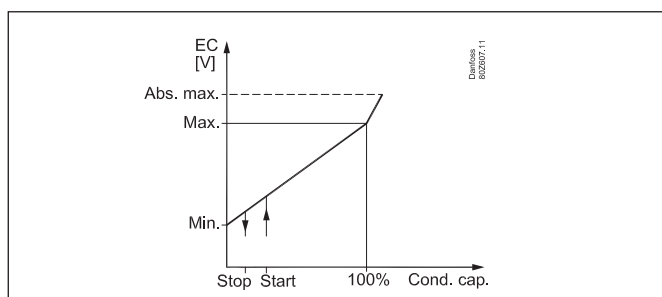

Heat recovery

A digital input can be activated.

When the signal is received, the reference for the gas cooler pressure will be raised to the configured value.

When the pressure of the heat recovery has been reached and the DI signal disappears, the reference will drop once again, though it will do so over the course of few minutes to prevent abrupt changes in the reference.

An optional relay outlet can be connected to heat recovery. The optional relay is activated when the controller allows for heat recovery.

Cooling will always have a higher priority than heat recovery. If this higher priority occurs, the relay will be deactivated and the reference for heat recovery will be cancelled. The cooling reference is now used for regulation until the temperatures and pressure allow for heat recovery to resume.

During heat recovery, regulation can be carried out in accordance with:

- Max. COP - Most energy-optimal.
- Max. HR - The highest achievable heat recovery.

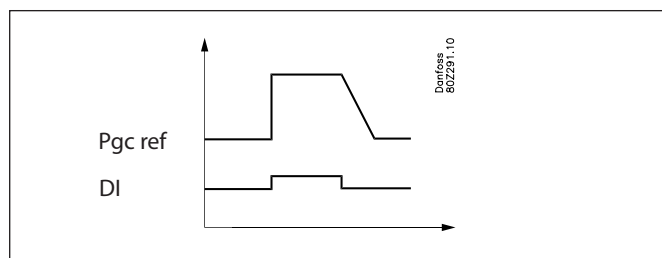

After start-up of the pack, e.g. after setting the main switch to "on", the heat recovery function input signal is ignored for 5 minutes.

Note: The AK-PC 572 heat recovery does not control the heat request. This requires an external thermostat or similar. It does also not protect the heat exchanger from high pressure due to boiling of water inside. This safety will also require external control.

Warning

Remember that the controller controls the gas pressure. If the regulation is stopped by the internal or external main switch, this control will stop as well. Risk of loss of charge.

4. Receiver control

The receiver pressure can be controlled so that it is kept at the desired reference point. This reference point is fixed at 6 bar above the reference point for Po-MT, with a user specified minimum reference. This control requires the installation of a receiver valve Vrec and a pressure transmitter.

Hot gas dump

This function is possible only if there is an available DO output.

This function allows for hot gas to be passed to the receiver if the pressure approaches Po-MT.

Hot gas will be shut off again when the pressure returns above the desired level.

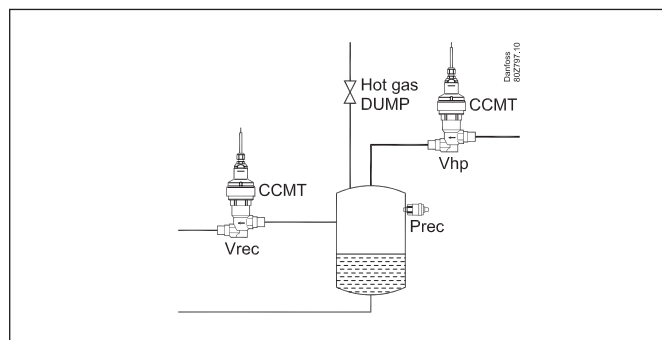

5. AUX functions and limitations

AUX1-DI and -DO

This function shares an input and output with an MT compressor 3. AUX1 is possible only if regulating using one or two compressors on the MT.

AUX1-DI can then be used as an alarm input.

AUX1-DO can then be used for liquid injection, DE-SH or hot gas dumping.

DO6

The output is a solid state output and reserved for a CR11. If CR11 is not used for regulation, DO6 can be used to control an oil valve.

Oil management

Oil management will share an output with a CR11 compressor.

Oil management can take place only if a CR11 is not used for regulation.

Oil management can be performed with a timer function or with a level signal from an oil receiver. This signal can only be included in the "OIL" input. If the input is not used for OIL it will be available and called AUX2-DI. It can then be used as an alarm input.

AUX2-DO

The potential relay output can be freely used for liquid injection, DE-SH or hot gas dumping.

AUX3-DI

This function shares an input with the heat recovery function.

AUX3-DI is possible only if heat recovery is not used.

AUX3-DI can then be used as an alarm input.

AUX3-DO

This function is reserved for heat recovery but only if a potential relay output is also required to be activated when heat recovery is regulated.

If the output is not used for heat recovery, it can be used for liquid injection, DE-SH or hot gas dumping.

AUX-DI as an alarm input

There are two alarm options:

- A "Fan error" that will be shown in the display and in the system unit if it occurs.
- A text alarm that will be shown in the display and in the system unit if it occurs.

Survey

| Connection | | "572" DI3 | "572" DO3 | "572" DO6 | HP DI1 | HP DO | Rec DI1 | Rec DO |
|--------------------|------------|--------------|--------------|--------------|-----------|----------|------------|-----------|
| 1. priority | | | | | | | | |
| MT3 | | x | x | | | | | |
| CR11 | | | | x | | | | |
| Heat recovery | | | | | | | x | (x) |
| 2. priority | | | | | | | | |
| Oil | No CR11 | | | x | (x) | | | |
| Fan error | Max. 1 | x | | | x | | x | |
| Alarm text | Max. 1 | x | | | x | | x | |
| Liquid injection | | | x | | | x | | x |
| DE superheat | | | x | | | x | | x |
| Hotgas dump | | | x | | | x | | x |

6. Safety functions

Control optimisation

The controller continually registers the different pressures in the system.

The pressures are automatically adjusted for the most energy-optimal pressure.

If the pressure approaches a threshold value, the controller will adjust the different references to maintain control.

Min./max. suction pressure Po

The suction pressure is recorded continuously.

If the measured value falls below the set minimum limit, the compressors will immediately cut out.

If it exceeds the max. value, an alarm will be generated once the time delay has elapsed.

LT HP Switch

On/off signal on a DI input.

If a signal is received, all LT compressors will immediately be stopped.

MT HP Switch

On/off signal on a DI input.

If a signal is received, all compressors will immediately be stopped.

Fan capacity will go to 100% when the Pgc measurement exceeds the reference.

CM-RC-01 MODBUS

If CM-RC-01 is controlled over MODBUS then it is recommended to add the DO for this compressor to a relay in the safety chain.

Min./max superheat via Ss and Po measurement

Temperature sensor on an AI input.

If superheating is higher or lower than the set limits, an alarm will be generated once the time delay has elapsed.

Max. discharge gas temperature Sd

Temperature sensor on an AI input.

There is an Sd for the MT group and an Sd for the LT group.

If the temperature nears the set max. temperature, the capacity of the compressor will be reduced.

The compressors will be stopped if the temperature nears the set max. temperature value.

Liquid injection in the MT suction line

This function is configured in the AUX_DO output.

There are no configuration values. The controller determines when liquid injection is required.

Sensor failure

If lack of signal from one of the connected temperature sensors or pressure transmitters is registered an alarm will be given.

- In the event of a Po error, regulation will continue with a set capacity in daytime operation (50%), and a set capacity in night operation (25%), but with a minimum of one step.
- When there is a Pgc sensor error then Vhp is operated on average OD.
- When there is an error on the Sd sensor the safety monitoring of the discharge gas temperature will be discontinued.
- When there is an error on the Ss sensor the monitoring of the superheat on the suction line will be discontinued.
- In the event of an error on the outdoor temperature sensor, Sc3, 35 °C will be used as a reference.

NB: A faulty sensor must be correct for 10 minutes before a sensor alarm is cancelled.

A sensor alarm can be reset manually by pushing the "X-button" for 2 seconds when the alarm is shown in the display "Active alarms".

Fan error alarm

On/off signal on a DI input. Possible only if the input is not used for its intended purpose.

If the signal is received, an alarm is given.

General DI alarm

On/off signal on a DI input. Possible only if the input is not used for its intended purpose.

The controller contains one general alarm input, to which alarm text and delay times can be connected.

Alarm and text will appear when the delay time has elapsed.

Info

In normal operating conditions, the temperature at Sd will be between 60 and 70 °C - depending on whether it is winter or summer.

If the "Heat reclaim" function is to raise the condensing pressure, the temperature may increase to 90° or higher.

The Sc3 sensor should be positioned so that it measures the air intake temperature for the gas cooler. If it measures a temperature that is too high, the system's COP will become impaired.

The Sgc signal must be stable. If this cannot be done using a surface sensor, it may be necessary to use an immersion tube sensor.

If the power supply to AK-PC 572 or the high pressure valve Vhp fails, the system cannot be controlled. We recommend installing an emergency supply (UPS) for both the controller and the valve to avoid faults. A relay in the UPS should be incorporated into the controller's safety circuit so that it can restart safely.

7. Display overview

7.1 End-user overview

The images in this daily user interface will depend on how the set-up is made. They will illustrate what is regulated.

Click on the "Right Arrow" to view e.g. the following images:

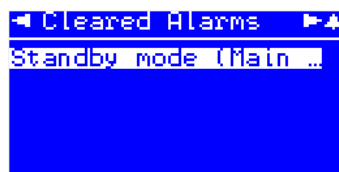
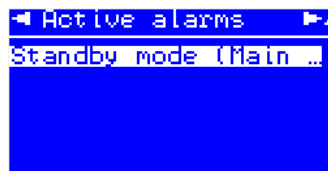
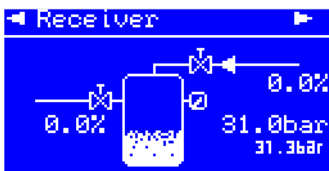
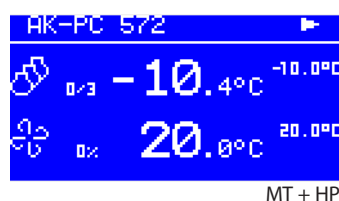
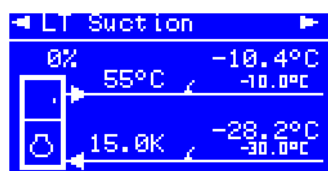
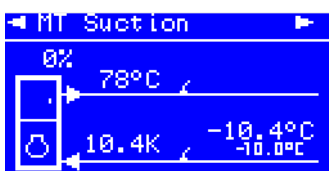

When an alarm is sent from the controller, you must advance to this display to see the alarm text. Then click on the alarm text to view the details relating to the alarm.

7.2 Set-up overview

There are 2 ways in which the controller can be set up. Select the one that is easiest for you: either “Wizard” or a review of “all parameters”.

Start screen upon delivery

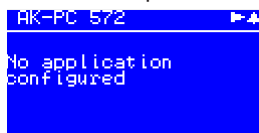

Hold “Enter” ↵ down for 2 seconds to come to password entry.



The default password upon delivery is 300. Use the arrow keys to set the password. End by pressing “Enter” ↵.

Operating principles

1. Select position using arrow keys
2. Select using “Enter” ↵
3. Use the “X” to return.

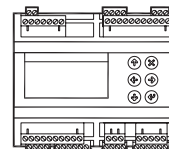

Select a set-up method. End by pressing “Enter” ↵.



Language

Choose from one of the possible languages.

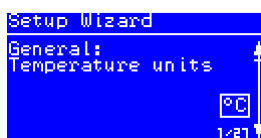

Wizard

Here you will be led through a series of settings, after which the controller will be ready for start. Image 1 of 27 is displayed here.

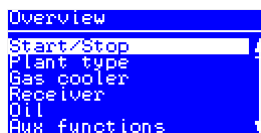

Parameter settings

Here is the start image for the possible settings.

Main Menu

The first setting is the Plant type

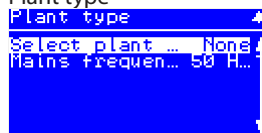

The following options are available here:

- Booster + HP
- MT + LT

When the Plant type has been selected, it will allow several settings to be made.

For example:

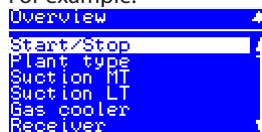

Continue to the next menus.

All settings are explained on the pages that follow.

8. Menu

SW: 1.0x

| Start/stop | | | |
|------------|---------------------------|---|--|
| | Main switch | <p>Main switch Start and stop regulation here. The configuration settings will require that regulation is stopped. If you try to enter a configuration setting when the regulation has started, the controller will ask if the regulation should be stopped. When all settings have been made and the main switch is set to "ON", the controller will enable the display of the various measurements. Regulation will start. (One external main switch must be "ON" before regulation starts.)</p> | On / Off |
| | Extern Main switch | <p>Status on External main switch It is possible to connect an external switch which can be used to start and stop regulation. Both the internal and external main switch must be ON before regulation starts. If the external cut-out is omitted, the dedicated input must be shorted.</p> | |
| Plant type | | | |
| | Select Plant type | <p>Plant settings: The following must be regulated: • Booster + HP • MT + HP</p> | Fac: None |
| | Mains frequency | <p>Frequency Set the net frequency</p> | 50 Hz / 60 Hz Fac: 50 Hz |
| Suction MT | | | |
| | Control status MT | Regulation status | |
| | Control status | Read the status of the functions in the control circuit here | |
| | Reference | The regulation reference can be read here | |
| | ToMT temperature | The measured PoMT pressure converted to temperature can be read here | |
| | PoMT Pressure | The measured pressure for the PoMT pressure transmitter can be read here | |
| | Requested capacity | Here the preferred connected capacity can be read as a % of total capacity | |
| | Running capacity | Here the connected capacity can be read as a % of total capacity | |
| | No. of running comp. | The number of compressors in operation can be read here | |
| | MC PoMT offset | The size of a reference displacement on PoMT required from the system unit (suction pressure optimisation function) can be read here | |
| | SdMT discharge temp. | The measured discharge temperature can be read here | |
| | SsMT Suction gas temp. | The measured suction gas temperature can be read here | |
| | Superheat MT | The actual superheat can be read here | |
| | Day / Night status | The status of the day/night function can be read here | |
| | Load shed | The status of the load shed function can be read here | |
| | HP Safety switch | The status of the security circuit can be read here | |
| | Injection ON MT | The status of the injection ON signal sent to the evaporator controllers can be read here | |
| | Liq. inj. suction line | The status of the liquid injection in the suction line can be read here | |
| | MC Load Shedding | The status of the load shed signal received from the system device can be read here | |
| | MC Night Setback | The status of the night increase signal received from the system device can be read here | |
| | Control settings | Regulation settings | |
| | Control mode | <p>Regulation type The regulation is normally set to "Auto", but it can be changed to "Off" or "Manual".</p> | MAN / OFF / AUTO Fac: AUTO |
| | Manual capacity | When setting to "Manual", a forced capacity setting can subsequently be entered in %. | Min: 0 % Max: 100% |
| | Setpoint | Enter the setpoint for the regulation (regulation reference = setpoint + different offsets) here An offset can originate from a night increase signal or from an override function on the system device. | Min: -55 °C Max: 20 °C Fab: -10 °C |
| | PI control selection | Set how quickly the PI regulation must react here: 1 = slowly, 10 = very quickly. | Min: 1 Max: 10 Fab: 5 |

| | | |
|--------------------------|---|---|
| Pump down | Pump down function To avoid too many compressor starts/stops with low load, it is possible to define a pump down function in which the last compressor is only stopped when the suction pressure falls to "Pump down limit Po". This limit has been set at 6 K below the reference point for Po. | Yes /No Fac: No |
| Injection OFF delay | Delay of the forced closing of expansion valves, if the controller calls for cut-in of compressors, but the compressors are in a locked situation and therefore cannot start. | Min: 0 s Max: 300 s Fac: 120 s |
| Configuration | Configuration | |
| Compressor mode | Set the type of compressor to be used for regulation: <ul style="list-style-type: none"> • Speed + Single***: First compressor has variable speed. The remaining ones are one-step units. • CR114+Single **: First compressor is CR114 compressor. The remaining ones are one-step units (in the event that CR11 is selected it will not be possible to select oil management) • Single-step only: All are one-step compressors • CM-RC + Single • CM-RC AO + Single • None Note: In speed mode the AO is controlled from min. to max. for compressor control. | DO-demand Fac: Speed+single |
| No. of compressors | Set the number of compressors on the suction circuit MT. This is a total amount. If regulating with two compressors only, DI3 and DO3 can be used for the AUX1 function. | DI + DO-demand Min: 1 Max: 3 Fac: 3 |
| Lead comp. 1 size | Set the nominal compressor capacity for the first compressor (it is defined under "Compressor mode") | Min: 1 m3h Max: 20 m3h Fac: 1 m3h |
| Comp. 2 size | Set the nominal compressor capacity for compressor 2 | Min: 1 m3h Max: 20 m3h Fac: 1 m3h |
| Comp. 3 size | Set the nominal compressor capacity for compressor 3 | Min: 1 m3h Max: 20 m3h Fac: 1 m3h |
| VSD Min. speed | ***: For speed Min. speed at which the compressor will cut out | Min: 10 Hz Max: 60 Hz Fac: 30 Hz |
| VSD Start speed | ***: For speed Minimum speed at which the compressor will start (must be set to a higher value than "VSD Min. speed") | Min: 20 Hz Max: 60 Hz Fac: 45 Hz |
| VSD Max speed | ***: For speed Highest permitted speed for compressor | Min: 40 Hz Max: 120 Hz Fac: 60 Hz |
| CR11 Period time | ** For CR11 Set the period time for the unloader valve (on time + off time) | Min: 10 s Max: 60 s Fac: 20 s |
| Comp1 min Cap | ** For CR11 Configure the minimum capacity at which the compressor will stop | Min: 10 % Max: 50 % Fac: 10 % |
| Comp1 start Cap | ** For CR11 Configure the capacity at which the compressor will stop | Min: 10 % Max: 100 % Fac: 30 % |
| Compressor timers | Compressor timers | |
| Lead comp.1 Restart | Min. period of time for re-starting the first compressor. Set the forced on+Off-time before it can be switched on again. The setting is to prevent incorrect operation. To prevent a compressor breakdown, the setting must be made in accordance with the requirements of the compressor supplier. | Min: 1 min. Max: 60 min Fac: 5 min |
| Comp. Restart | Min. period of time for restarting remaining compressors. Set the forced On+Off-time before it can be switched on again. The setting is to prevent incorrect operation. | Min: 1 min. Max: 60 min Fac: 5 min |

| | Compressor status | Compressor status | |
|--|-------------------------|---|--|
| | Comp. 1 status | Read the operating status for compressor 1 here. The following information may appear: Alarm - Alarm situation Main Sw. off - Compressor is stopped Manual ctrl. - Compressor is cut out on safety input (DI safety input) High Sd temp. - Stopped due to high Sd temperature Ready - Compressor is ready to start OFF timer - Compressor is waiting for Min. OFF timer to expire Min. ON timer - Compressor is waiting for Min. ON timer to expire Running - Compressor is running Disabled - Compressor has been taken out of operation (compressor service) | |
| | Comp. 2.... | The same function for the remaining compressors | |
| | CM-RC status | CM-RC status | |
| | Actual avg. capacity | Average capacity delivered in percentage. | |
| | Discharge temp | Discharge temperature in °C | |
| | Suction pressure | Suction pressure in bar(g) | |
| | Discharge pressure | Discharge pressure in bar(g) | |
| | Evap. SST | Calculated saturated suction temperature (SST) in °C | |
| | Envelope status | Envelope operation status: • Stopped • Starting • Running • Stopping • Warning (Inside envelope) • Critical (Outside envelope) • Fault | |
| | Envelope zone | Envelope operation status ¹⁾ : • Inside • SST low SDT low • SST low • SST low SDT high • SDT high • SST high SDT high • SST high • SST high SDT low • SDT low | |
| | Compressor type | Compressor type ²⁾ | |
| | Motor power consumption | Estimated motor power consumption in kW | |
| | Motor drive frequency | Motor drive frequency (speed) in Hz. | |
| | CM-RC alarm | CM-RC alarm | |
| | No of alarms | Number of active alarms | |
| | Highest severity | Highest severity of any active alarm status: • None • Log • Event • Info • Warning • Critical • Fault | |
| | Reset level | Reset level required to clear any active alarm: • None • Auto • Timer • Extern reset • Restart | |
| | Alarm reset | This initiates alarm reset command to Bizter IQ • No • Yes Note: There will be a delay of one minute before a new "Alarm reset" can be transmitted. | |

¹⁾ See Bizter IQ manual for further details on envelope operations status

²⁾ See Bizter IQ manual for further details on connected compressor type.

| | | |
|----------------------------|--|--------------------|
| Alarm 1 | Code of highest ranked alarm. Short description of active alarm. Alarm description: 0: No alarm, 1: 1100 Serial timeout, 3: 3001 SST low SDT low, 4: 3002 SST low, 5: 3003 SST low SDT hi, 6: 3004 SDT high, 7: 3005 SST hi SDT hi, 8: 3006 SST high, 9: 3007 SST hi SDT low, 10: 3008 SDT low, 11: 3010 Startup timeout, 12: 3011 Config failure, 15: 3500 Oil level low, 18: 4201 Motor phase err, 19: 4202 Motor phase seq, 20: 4301 Motor temp. hi, 49: 6700 Cfg: No file, 50: 6701 Cfg: CRC Error, 52: 6703 Cfg: Read only, 54: 6810 HW: 3.3V, 55: 6811 HW: User 5V, 62: 7304 Motor Thermistor, 68: 3400 Suc. press. Low, 69: 3411 Dis. press high, 70: 6813 HW: 24V, 71: 3027 Start before un, 74: 3022 Too many cmp st, 78: 3302 Dis. temp. high, 84: 4302 Motor tmp coold, 85: 7308 Discharge temp., 86: 7320 Aux temp. error, 90: 3431 High press swit, 91: 6900 Datalog error, 94: 7403 Suc. press. Low, 95: 7404 Suc. press high, 96: 7405 Dis. press. Low, 97: 7406 Dis. press high, 98: 3024 Min cmp stop tim, 99: 7406 Dis. press high, 98: 3024 Min cmp stop tim, 99: 3025 Min cmp run tim. 100: 3026 Min restart tim, 101: 3310 Fan cycle excee, 102: 3520 Oil inj. no eff, 119: 1000 Too many rst 24, 120: 1001 Too many rst 1h, 133: 3501 Oil flow low, 134: 3502 Oil press. Low, 135: 4220 Motor freq. low, 136: 4221 Motor freq high, 137: 3503 Oil stop valve, 145: 6815 HW Sensor 1-24V, 146: 6816 HW Sensor 2 – 24V, 150: 3030 Act cmd no run, 153: 4003 Motor curr high. Info: First number before “.” is value read on MODBUS. Second number corresponds to alarm according to Bitzer IQ/CM-RC-01 Compressor Control Module manual. Note: See Bitzer IQ manual for further detailed description on alarm. | |
| Alarm 2 | Code of second highest ranked alarm. Short description of active alarm. See alarm 1 for alarm description. | |
| Alarm 3,4 and 5 | Short description of active alarm. See alarm 1 for alarm description. | |
| Compressor capacity | Compressor capacity | |
| Comp. 1 cap. | Read the connected capacity of the compressor (0-100%) here | |
| Comp. 2..... | The same function for the remaining compressors | |
| Compressor runhours | Compressor run hours | |
| Reset runtime/cycles | Reset all of the hour counters and start counters for the subsequent compressors here. | |
| Comp.1 Runtime L | Read the total operating time of the compressor (in hours) here | |
| Comp.2..... | The same function for the remaining compressors | |
| Compressor cycles | Compressor cycles | |
| Comp.1 Cycle total | Read the number of times the compressor has been started here | |
| Comp.2..... | The same function for the remaining compressors | |
| Compressor service | Compressor service | |
| Comp.1 out of service | The compressor can be taken out of operation, so that the controller regulates without this compressor. No = Normal regulation Yes = Regulation is carried out without this compressor, and no alarms are generated by it. | Yes /No Fac: No |
| Comp.2..... | The same function for the remaining compressors | |
| Suction LT | | |
| | Suction group LT . Please see descriptions under suction group MT. (In suction group LT it is not possible to use: Bitzer CR11, Po optimisation and night-time reduction). | |
| Gas cooler | | |
| Control status | Regulation status | |
| Control status | Here you can read the status of the condenser circuit, e.g.: • Main Sw. off - Main switch = OFF • Normal - Controller working as expected • Emergency – Emergency Controls • Manual ctrl - Capacity control is set in manual control mode | |
| Pgc | The current value of the regulation sensor can be read here | |
| Sgc | The current value of the regulation sensor can be read here | |
| Pgc Reference | The total regulation reference can be read here | |
| Sgc Reference | The total regulation reference can be read here | |
| Vhp OD | Here you can see the opening degree of the Vhp valve | |
| Fan running capacity | Here the connected capacity can be read as a % of total capacity | |

| | | | |
|--|--------------------------|--|--|
| | Fan requested capacity | Here the preferred connected capacity can be read as a % of total capacity | |
| | Sc3 air on cond. | The measured outdoor temperature with sensor Sc3 can be read here | |
| | Heat recovery status | Here the status of the heat recovery function can be read | |
| | HP safety switch | The status of the HP safety switch can be read here | |
| | Day / night status | Here you can see whether the controller is in Day or Night mode | |
| | Control settings | Control settings | |
| | Vhp control mode | Regulation type The regulation is normally set to "Auto", but it can be changed to "Manual". | MAN / AUTO Fac: AUTO |
| | Vhp manual capacity | When setting to "Manual", capacity can then be forced set in %. | Min: 0 % Max: 100% |
| | Vhp Easy PI | Set how quickly the PI regulation must react here: 1 = slowly, 10 = very quickly. (For setting 0 "User def." the special settings options will open. Kp, Tn. These options are only for trained staff.) | Min: 0 (User def.) Max: 10 Fac: 5 |
| | Vhp Kp | Amplification factor for PI regulation (can be viewed and configured only when the previous menu has been set to "0"). If the Kp value is lowered, regulation runs more smoothly. | Min: 0,5 Max: 10 Fac: 2,0 |
| | Vhp Tn | Integration time for PI regulation (see above). If the Tn value is increased, regulation will run more smoothly. | Min: 30 Max: 300 Fac: 75 |
| | Vhp min OD | Limitation of the valve's degree of closing | Min: 0% Max: 15% Fac: 0% |
| | Average OD | Readout of the average opening degree of the valve | Min: 0% Max: 100% Fac: 35% |
| | Fan control mode | Regulation type The regulation is normally set to "Auto", but it can be changed to "Manual". | MAN / OFF / AUTO Fac: AUTO |
| | Fan manual capacity | When setting to "Manual", capacity can then be forced set in %. | Min: 0 % Max: 100% |
| | Fan Easy PI | Set how quickly the PI regulation must react here: 1 = slowly, 10 = very quickly. (For setting 0 "User def." the special settings' options will open. Kp, Tn. These options are only for trained staff.) | Min: 0 (User def.) Max: 10 Fac: 5 |
| | Fan Kp | Amplification factor for PI regulation (can be viewed and configured only when the previous menu has been set to "0"). If the Kp value is lowered, regulation runs more smoothly. | Min: 0,5 Max: 50 Fac: 10 |
| | Fan Tn | Integration time for PI regulation (can be viewed and configured only when the previous menu has been set to "0"). If the Tn value is increased, regulation will run more smoothly. | Min: 10 s Max: 900 s Fac: 180 s |
| | dt subcool | Here you can set the desired sub-cooling | Min: 1,0 K Max: 30,0 K Fac: 4,0 K |
| | Heat recovery | Define whether a heat recovery cycle should be started with a signal on a DI input here. • No: No function • DI only: A DI input is reserved. When a signal is registered, the heat recovery function reference will become active. • DI and DO: Choose this setting if you are also activating an optional relay output (HR on the receiver module). | Fac: No |
| | Heat reclaim mode | Here you configure the controller for when a signal is received for heat recovery. You can choose between raising the temperature to achieve maximum heat recovery or maintain temperature at the level with the highest efficiency. | High effect / Max. recovery Fac: High effect |
| | Heat recovery SP | Here you can set the reference that the controller will switch to when heat recovery is desired. | Min: 70 bar Max: 100 bar Fac: 80 bar |
| | Fan configuration | Configuration of fans | |
| | EC Start | Here you can configure the controller capacity at which the fans will start. (With a setting of 5% the fans will start when the desired controller capacity exceeds 5% of the EC Min. setting). | Min: 0% Max: 20% Fac: 0% |
| | EC Min. | Here you configure the lowest permitted speed for the fans in % (% of output signal). If lower capacity is required, this minimum speed should be maintained all the way down to 0% capacity. At 0% capacity, the system stops completely. | Min: 0% Max: 30% Fac: 0% |

| | | | |
|--------------------|------------------------------|--|---|
| | EC Max. | Here you configure the fan speed in % when regulating at 100% capacity. (Typically 80% of the output signal). | Min: 30% Max: 100% Fac: 80% |
| | EC abs max Sgc | Here you configure the Sgc temperature at which the fan speed is raised to the absolute maximum (100% of the output signal). | Min: 20 °C Max: 60 °C Fac: 60 °C |
| | Fan status | Fan status | |
| | Fan speed | Here a reading of the desired condenser fan capacity is provided in % | |
| | EC start/stop | Fan operation status can be read here | |
| | Reset runtime cycl. | Here the two counters "run time" and "couplings" can be reset | |
| | EC Runtime total | Here you can see how many hours the fans have been operational for since the last reset | |
| | EC Cycl. total | Here you can see how many fan starts there have been since the last reset | |
| Receiver | | | |
| | Rec. control status | Receiver status | |
| | Control status | Here you can see the status of the receiver controller: Off / Idle / Emergency / Normal / Hot gas dump | |
| | Prec | Here you can see the receiver pressure | |
| | Prec reference | Here you can see the reference point for the receiver pressure | |
| | Vrec OD | Here you can see the opening degree of the valve Vrec in % | |
| | Hot gas dump | Here you can see if the hot gas dump is active. | |
| | Rec. control settings | Here you can see the status of the valve for hot gas dumping | |
| | Control mode | Controller type The controller is normally set to "Auto" but can be changed to "Manual". | MAN / AUTO Fac: AUTO |
| | Vrec manual capacity | When setting to "Manual", capacity can then be forced set in %. | Min: 0 % Max: 100% |
| | Prec max. | Here the maximum receiver pressure can be configured | Min: 34 bar Max: 89 bar Fac: 59 bar |
| | Easy PI select | Set how quickly the PI regulation must react here: 1 = slowly, 10 = very quickly. (For setting 0 "User def." the special settings' options will open. Kp, Tn. These options are only for trained staff.) | Min: 0 (User def.) Max: 10 Fac: 5 |
| | Kp | The reinforcement factor for the PI controller (can only be viewed and configured when the previous menu has been set to "0"). If the Kp value is lowered, regulation runs more smoothly. | Min: 0,5 Max: 10 Fac: 2,0 |
| | Tn | Integration time for PI regulation (see above). If the Tn value is increased, regulation will run more smoothly. | Min: 30 Max: 300 Fac: 75 |
| | Manual hot gas | Here you can override the hot gas valve. (Only if hot gas dump is defined in the AUX section). | Auto Man on Man off |
| | Prec min. Ref | Minimum reference for the receiver pressure. | Min: 20 bar Max: 50 bar Fac: 20 bar |
| Oil Control | | | |
| | | Limitation It is only possible to use oil management if the solid state outputs (DO5 and DO6) are free. If regulating using compressor type Bitzer CR11, the two outputs will be used by the compressor and oil management cannot be performed. | DO-demand |
| | Control type | Adjust whether oil management will be used. You can choose whether pulse controls run only with a timer function or whether pulse controls are performed only when there is a signal from a level switch. | None/Timer only/ Level Fac: None |
| | Oil control status | Here you can see the oil management status: None / Main switch off / Idle / Valve open / Delay before next pulse | |
| | Oil cycle time | Adjust the period between pulses. (Only if regulated with the "Timer only" setting) | Min: 180 s Max: 1800 s Fac: 300 s |
| | Oil pulse duration | Adjust the valve opening time for each pulse | Min: 1 s Max: 30 s Fac: 5 s |

| Safety monitoring | | | |
|-------------------|----------------------------|---|---|
| | PoMT Min. limit | Safety limits for min. PoMT If a low value is registered, all compressors will cut out | Min: -55 °C Max: 30 °C Fac: -40 °C |
| | PoMT Max. alarm | Alarm limit for high PoMT If a high value is registered, an alarm will be generated. If a higher value is registered during a load limitation, the load limitation will be cancelled until Po has returned to the reference. | Min: -30 °C Max: 30 °C Fac: 5 °C |
| | Superheat Min. MT | Alarm limit for insufficient superheating (Superheating is measured in the suction line by PoMT and SsMT.) | Min: 0 K Max: 20 K Fac: 4 K |
| | Superheat Max. MT | Alarm limit for excess superheating | Min: 20 K Max: 80 K Fac: 50 K |
| | SdMT Max. limit | Safety limit for max. SdMT At 10 K under the set value, the compressor capacity will be reduced, and the entire condenser capacity will cut in. If the threshold is exceeded, the entire compressor capacity will cut out. | Min: 60 °C Max: 160 °C Fac: 140 °C |
| | PoLT Min. limit | Same settings as for the MT group | |
| | PoLT Max. alarm | | |
| | PoLT Max. delay | | |
| | Superheat Min. LT | | |
| | Superheat Max. LT | | |
| | SdLT Max. limit | | |
| | Pgc Max. | Safety limit for max. Pgc If Pgc exceeds the value set here minus 3 K, the entire fan capacity will cut in, and compressor capacity will be reduced by 25% for every 30 seconds. If Pgc exceeds the threshold value, the entire compressor capacity will immediately cut out, and an alarm will be generated when the delay time expires. | Min: 29 bar Max: 139 bar Fac: 104 bar |
| | Safety restart time | Delayed start-up following safety cut-out If a safety cut-out has occurred due to "Sd max. limit", "Pgc max. limit" or "Po min. limit", the compressors must be kept stopped for a defined period of time. The amount of time can be set here. | Min: 0 min. Max: 60 min. Fac: 2 min. |
| | Sensor alarm reset | Reset alarm after sensor error When a sensor error has occurred, an O.K. signal must be registered within a specified number of minutes before the controller resets the alarm. The regulation will be resumed as soon as the sensor signal is O.K. | Min: 1 min. Max: 30 min. Fac: 10 min. |
| Aux. functions | | | |
| | Digital input | | |
| | DI AUX1 | If there are only two compressors in the MT circuit, the DI3 output will be available for AUX1. The input can then be used for an optional function. You can choose between the functions "Fan error" or "Alarm". | DI-demand |
| | DI AUX2 | If level signals are not desired for oil management, the "DI on the high pressure module" input will be available. The input can then be used for an optional function. You can choose between the functions "Fan error" or "Alarm". | DI-demand |
| | DI AUX3 | If an "HR req" signal is not desired for use in heat recovery, the "DI on the receiver module" input will be available. The input can then be used for an optional function. You can choose between the functions "Fan error" or "Alarm". | DI-demand |
| | DI alam delay | Delay time for a DI alarm | Min: 0 min. Max: 360 min. Fac: 0 min. |
| | DI alarm text | Here you can choose what text to display in the event of a DI alarm. The text can be seen in the display and can also be sent to a system unit. Choose between the following texts: General Alarm, Low Pressure, High Pressure, High Temperature, Low Temperature, Oil Level, Oil Temperature, Liquid Level, Leak Detection, Inverter Fault, Dry Cooler, Pump, Motor Protection Comp, Brine Pressure. Note: There is only one alarm available. The signal will be received in one of the three AUX inputs. | |

| | | | |
|---------------|---------------------------|--|--|
| | Digital output | | |
| | DO AUX1 | If there are three compressors in the MT circuit, the optional relay output DO3 will be used by MT3. If there are only two compressors in the MT circuit, the optional relay can be used by one of the following functions: Liquid injection, DE-SH or hot gas dumping | DO-demand |
| | DO AUX2 | Relay output in the high pressure module You can choose between the following functions: Liquid injection, DE-SH or hot gas dumping | DO-demand |
| | DO AUX3 | Relay output in the receiver module You can choose between the following functions: Liquid injection, DE-SH or hot gas dumping | DO-demand |
| System | | | |
| | Display | Select views on the display | - |
| | Language | Choose from the following languages: English, German, French, Danish, Spanish, Italian, Portuguese, Dutch, Russian, Polish, Czech, Turkish, Hungarian, Croatian, Serbian, Romanian | Fac: UK English |
| | Pressure units | Pressure unit Select bar or PSIG | Bar / PSIG Fac: bar |
| | Temperature units | Temperature unit Select °C or °F. | °C / °F Fac: °C |
| | Time format | Time format Choose 12-hour or 24-hour format. | 12 / 24 Fac: 24 h |
| | Screen saver time | Screen saver time If no buttons have been pushed for a specific period of time, the light in the display will be minimised. The light level will be restored upon renewed activity. | Min: 1 min. Max: 60 min. Fac: 1 min. |
| | User logout time | Log-off time If buttons have not been pressed within a specified period of time, the screen will return to the overview display. Afterwards, the user will have to log on again. If the time is changed, the new time will apply the next time the user logs in. If you log out here without waiting for the time-out period to elapse, go to the overview display and hold down the "X" button for 3 seconds. | Min: 1 min. Max: 60 min. Fac: 2 min. |
| | Display contrast | Adjust contrast | Min: 0 Max: 100 Fac: 30 |
| | Password | Access code | |
| | Password level 1 | The settings in the controller can be protected with three levels of access codes. Level 1: End user settings | Fac: 100 |
| | Password level 2 | Level 2: Adjusting installer level | Fac: 200 |
| | Password level 3 | Level 3: Configuration of system settings (configuration menu) The access code is a number between 001 and 999. | Fac: 300 |
| | Real time clock | Date and time Used by alarm function. | Year, month, date Hours, minutes |
| | Network | Network | - |
| | MODBUS Address | Set the address of the controller here if it is connected to a system device via data communication. | Min: 0 1 Max: 120 Fac: 1 |
| | Baudrate | The system unit usually communicates with 38.4. If it is changed in the system unit to for example, "SLV" mode (19.2), the setting must also be changed to 19.2 here in the controller. | Fac: 384 |
| | Serial mode | The value must not be changed | Fac: 8E1 |
| | MT Comp. 1 MODBUS address | MT MODBUS address for Bitzer IQ CM-RC-01 speed compressor | Min: 0 Max: 120 Fac: 10 |
| | LT Comp. 1 MODBUS address | LT MODBUS address for Bitzer IQ CM-RC-01 speed compressor. | Min: 0 Max: 120 Fac: 20 |
| | Reset to factory | Return to factory settings If this function is set to "YES", all settings will be returned to factory default settings, and the alarm list will be cleared. | |

| I/O Configuration | | |
|--|--|--|
| <p>Most connections have been given in advance and cannot be changed. See the connection diagram.</p> <p><i>For digital outputs, define whether the function will be active for an activated or deactivated relay.</i></p> <p><i>For digital inputs, define whether the function/alarm will be active for an interrupted or shut-off switch.</i></p> <p><i>For analogue outputs, define whether the output signal should be 0 – 5 V or 0 – 10 V</i></p> <p><i>For analogue inputs, define:</i></p> <p>Temperature sensors: Normally, the sensor type is a Pt1000 model. Calibration value (+/- 10 °C)</p> <p>Pressure sensors: Signal type: 4 – 20 mA, 1 – 5 V or 10 – 90% ratiometric of 5 V supply voltage Minimum and maximum pressure range Calibration value (+/- 5.0 bar)</p> <p>Please note: If a function has been connected to an input or output and is subsequently deselected in the configuration, the function in question will be marked with an exclamation mark (!). In this case, you must either activate the function in the configuration, or deselect the function on the input or output in question.</p> | | |
| Digital output | <p>On/off outputs</p> <p>Most outputs have been locked to a function. These are as follows:</p> <ol style="list-style-type: none"> 1: MT compressor 1 2: MT compressor 2 3: MT compressor 3. If no MT3 compressor is connected, the output must be configured for 'None'. The output can then be used for an AUX1 function. The function can be configured in the AUX menu. 4: External alarm unit 5: Solid state output. Reserved for a Bitzer CRIL. 6: Solid state output. Reserved for a Bitzer CRIL. If a Bitzer CRIL is not connected, the output can be used to manage an oil valve. 7: LT compressor 1 8: LT compressor 2 <p>When the compressor is idle, there will be no voltage to the bypass valves. Voltage is connected immediately before the compressor is started.</p> | On Off |
| Digital input | <p>On/off inputs</p> <p>Most inputs are locked to a function. These are as follows:</p> <ol style="list-style-type: none"> 1: Signal from compressor 1 in the MT circuit. Once a signal is received, the compressor will cut out. When monitoring an Sd temperature in a Bitzer CRIL, the temperature signal must be registered by an external thermostat that will then issue an on/off signal via the input. 2: Signal from compressor 2 in the MT circuit. Once a signal is received, the compressor will cut out. 3: Signal from compressor 3 in the MT circuit. Once a signal is received, the compressor will cut out. If not regulating with an MT3 compressor, the input can be used for an AUX1 function. 4: Signal from external main switch. Regulation starts when a signal is received. 5: Signal from the high pressure switch in the MT circuit. Once a signal is received, the circuit will cut out. 6: Signal from the high pressure switch in the LT circuit. Once a signal is received, the circuit will cut out. 7: Signal from compressor 1 in the LT circuit. Once a signal is received, the compressor will cut out. 8: Signal from compressor 2 in the LT circuit. Once a signal is received, the compressor will cut out. <p>The signal must be defined for each input. Should the function take effect when the input is Off or when it is On</p> | On Off |
| Analog output | <p>0-10 V outputs</p> <p>The outputs have been locked to the following functions:</p> <ol style="list-style-type: none"> 1: Signal to the fans on the gas cooler 2: Not used 3: Signal for the speed controls in compressor 1 in the MT circuit 4: Signal for the speed controls in compressor 1 in the LT circuit | |
| Analog input | <p>Analogue inputs</p> <p>The outputs have been locked to the following functions:</p> <ol style="list-style-type: none"> 1: Pressure transmitter PoMT 2: Pressure transmitter PoLT 3: Pressure transmitter Pgc 4: Pressure transmitter Prec 5: Temperature sensor SsMT 6: Temperature sensor SdMT 7: Temperature sensor Sgc 8: Temperature sensor Sc3 | <p>Pressure signal: Ratiometric</p> <p>Temperature signal: Pt 1000 ohm</p> |

| | | | |
|---------------------------|---|---|----------------------|
| | Stepper outputs | Here you can set the valve type. Choose between the following types: CCM10...40, CCM3L...8L, CCMT2...42, CTR20, ETS6...400. Choose user-defined if there is a different type of valve. All valve data must then be configured directly in the valve module. The control unit MMIMYK can be used. | Fac: CCMT-2 |
| I/O Status | | | |
| | Digital output 1: . . 8: | Status of on/off outputs Here you can see if the function is on or off. | |
| | Digital input 1: . . 8: | Status of on/off inputs Here you can see the status of the function/alarm. | |
| | Analog output 1: 3: 4: | Status of analogue outputs Here you can see the size of the output signals as a % of max. signal. | |
| | Analog input 1: . . 8: | Status of analogue inputs Here you can see pressure and temperature values received by the controller. The values include calibration. | |
| | Expansion module Vhp OD Vrec OD Ss-LT Sd-LT Oil / Aux 2 DI HR / Aux3 DI Aux 2 DO HR / Aux 3 DO HP SW version Rec. SW version | Status of the expansion modules Here you can see the actual opening degree of the valves, the temperatures in the LT circuit and status of the inputs and outputs. | |
| | CM-RC MT | Readout status from MT Bitzer IQ module: 1. Suction pressure in bar(g) 2. Discharge pressure in bar(g) 3. Discharge temperature in °C 4. HP Switch (ON/OFF) 5. Crank case oil heater (ON/OFF) 6. Oil sensor 1 (ON/OFF) 7. Oil sensor 2 (ON/OFF) 8. Head cooling fan (ON/OFF) 9. Motor overheat PTC in ohm | |
| | CM-RC LT | Same menu as MT except this is LT | |
| I/O Manual Control | | | |
| | Digital output | Manual control of a relay output Under normal regulation, the function of the relay will be in "Auto". In the event of an override, the function will be switched to either "On" or "Off". Remember to switch to "Auto" when the override is to be completed. | Auto / On / Off |
| | Analog output | Manual control of analogue output During normal regulation, the function of the output will be "Auto". In the event of an override, the function must first be changed to "Manual", after which the output signal can be changed from 0-100%. Remember to switch to "Auto" when the override is to be completed. | Auto / Man 0-100% |
| | Expansion modules | Manual control of a connection in the HP module and receiver module During normal regulation, the function of the output will be "Auto". In the event of an override, the function must first be changed to "Manual". The function can then be set to the desired value. Remember to switch to "Auto" when the override is to be completed. | |

| Alarm priorities | | | |
|------------------|--|--|---|
| | General Standby mode: Sensor error: Output in MANUAL: | Alarm priorities The controller will issue an alarm notification if a specific incident occurs. Each incident is set to indicate the importance of each alarm, but it is possible to modify the importance of each. Choose between the following priority levels: Critical: Important alarms that require a high level of attention. Severe: Alarms of intermediate importance Normal: No important alarms Disable: Alarms set to this priority level will be cancelled. Factory setting for the alarm can be seen on page 22. | Critical Severe Normal Disable |
| | Suction group MT Low pressure: High pressure: Superheat High Sd temperature Compressor safety: | | |
| | Suction group LT Low pressure: High pressure: Superheat High Sd temperature Compressor safety: | | |
| | HP Fan safety: HP control: | | |

9. Alarm list

| Alarm text | Reason | Priority setting | Default value |
|------------------------------------|---|-----------------------------|---------------|
| General alarms | | | |
| Standby mode (Main sw. OFF) | Alarm when control is stopped by internal or external Main Switch (DI input "Main Switch") | Standby mode | Normal |
| PoMT sensor error | Pressure transmitter signal from PoMT defective | Sensor error | Normal |
| PoLT sensor error | Pressure transmitter signal from PoLT defective | | |
| SsMT sensor error | Temperature signal from SsMT suction gas temp. defective | | |
| SsLT sensor error | Temperature signal from SsLT suction gas temp. defective | | |
| SdMT sensor error | Temperature signal from SdMT discharge gas temp. Sd defective | | |
| SdLT sensor error | Temperature signal from SdLT discharge gas temp. Sd defective | | |
| Pgc sensor error | Pressure transmitter signal from Pgc defective | | |
| Prec sensor error | Pressure transmitter signal from Prec defective | | |
| Sgc sensor error | Temperature signal from Sgc defective | | |
| Sc3 sensor error | Temperature signal from Sc3 defective | | |
| Missing expansion module | Alarm when one of the extension modules is missing. | Sensor error | Normal |
| Output in manual mode | An output is set in manual mode | Output in MAN mode | Normal |
| Suction MT alarms | | | |
| PoMT Low suction pressure | Minimum safety limit for suction pressure PoMT has been violated | Low pressure PoMT | Normal |
| LP safety switch cut out MT | Low safety limit for external low pressure switch has been violated (DI input "LP switch MT") | | |
| PoMT High suction pressure | High alarm limit for PoMT has been exceeded | High pressure PoMT | Critical |
| SsMT High superheat | Superheat in suction line MT too high (measured by PoMT and SsMT) | Superheat MT | Normal |
| SsMT Low superheat | Superheat in suction line MT too low (measured by PoMT and SsMT) | | |
| SdMT High discharge temp. | Safety prevention limit for SdMT discharge temperature has been exceeded (10K below safety limit) | High disch. temp.SdMT | Critical |
| Comp. 1MT High disch. temp | Safety limit for discharge gas temperature has been exceeded | Compressor safety cutout MT | Normal |
| Comp 1-3MT safety cut out | Compressor no. 1-3 MT has been cut out on general safety input (DI1, DI2, DI3) | | |
| MT suction alarm | Alarm if set to manual control | High pressure PoLT | Critical |
| HP MT safety switch cutout | Alarm if MT-HP input has been activated | HP Control / Receiver | Critical |
| MT missing Modbus | Alarm if MODBUS communication times | Sensor error | Normal |
| MT - CM Restart condition detected | Alarm when restart condition is detected on Bitzer IQ module | Sensor error | Normal |
| Bus MT1 safety cut out | Alarm when ICP locked, a fault is detected, or MODBUS error is detected on Bitzer IQ module | High pressure PoLT | Critical |
| Suction LT alarms | | | |
| PoLT Low suction pressure | Minimum safety limit for suction pressure PoLT before cut-out | Low pressure PoLT | Normal |
| LP safety switch cut out LT | Low safety limit for external low pressure switch has been violated (DI input "LP switch LT") | | |
| PoLT High suction pressure | High alarm limit for PoLT has been exceeded | High pressure PoLT | Critical |
| SsLT High superheat | Superheat in suction line LT too high (measured by PoLT and SsLT) | Superheat LT | Normal |
| SsLT Low superheat | Superheat in suction line LT too low (measured by PoLT and SsLT) | | |
| SdLT High discharge temp. | Safety prevention limit for SdLT discharge temperature has been exceeded (10K below safety limit) | High disch. temp. SdLT | Critical |
| Comp. 1LT High disch. temp | Safety limit for discharge gas temperature has been exceeded | Compressor safety cutout LT | Normal |
| Comp 1-2LT safety cut out | Compressor no. 1-2 LT has been cut out on general safety input (DI7, DI8) | | |
| MT suction alarm | Alarm if set to manual control | High pressure PoLT | Critical |
| HP LT safety switch cutout | Alarm if LT-HP input has been activated | HP Control / Receiver | Critical |
| LT missing Modbus | Alarm if MODBUS communication times | Sensor error | Normal |
| LT - CM Restart condition detected | Alarm when restart condition is detected on Bitzer IQ module | Sensor error | Normal |
| Bus LT1 safety cut out | Alarm when ICP locked, fault is detected, or MODBUS error is detected on Bitzer IQ module | High pressure PoLT | Critical |
| Gas cooler alarms | | | |
| Prec high alarm limit | Alarm from the receiver | High receiver pressure | |
| High gas cooler pressure | Pgc registers a too high pressure | High pressure Pc | Critical |
| Common fan alarm | A fan is reported as defective via the shared safety input (DI input "Fan Alarm") | Fan Alarm | Normal |
| Hot gas dump manual control | Hot gas dump set to manual control | Output in MAN mode | Normal |
| HP manual control | Alarm when Vhp manual capacity is set to manual mode | Output in MAN mode | Normal |
| Receiver manual control | Alarm when Vrec manual capacity is set to manual mode | Output in MAN mode | Normal |
| Prec high limit alarm | Alarm from receiver | HP Control / Receiver | Critical |
| High gascooler pressure | Alarm from HP control | HP Control / Receiver | Critical |
| FAN manual control | Alarm if set to manual control | Output in MAN mode | Normal |

| | | | |
|---------------------------------------|--|----------------------|--------|
| Oil alarm | | | |
| High oil level in separator | Alarm when high oil level in separator is detected | Compressor MT safety | Normal |
| Extension modules | | | |
| Vhp battery alarm, Vrec battery alarm | Alarm when battery alarm is detected | Sensor error | Normal |
| Vhp valve alarm, Vrec valve alarm | Alarm when alarm is detected on extension module | Sensor error | Normal |
| Display alarm | | | |
| EER31 | See below | | |

Sensor alarms

Sensor alarms shut off automatically when the sensor has been O.K. for 10 minutes.

If you have corrected the sensor error and want to perform a manual, forced removal of the alarm, go to the "Alarm detail display".

Press and hold the "X" key for 2 seconds here.

ERR31
Alarm on the external display - MMIGRS2

If the communication to the display is not carried out correctly, it will send an "ERR31" error notification.

This may be caused by the displayed terminations not being installed, or that there have been interruptions in data communication during the time when the display retrieves the basic information from the controller. Once the terminations have been inspected, you should then check the software version of the external display. This is done by holding down the Enter key and the X key for 5 seconds, until the Bios menu appears. Next, press the X key and read off the software version in the bottom right corner. The software version must be 1.13 or newer.

Once the display's software version has been checked, check the display's settings as follows:

1. Hold the Enter key and the X key down for 5 seconds, until the Bios menu appears.
2. Select the "MCX selection" menu
 - Select the "Clear UI" line and press Enter
 - Select the "Autodetect" line and press Enter
3. Press the X key to return to the Bios menu
4. Select the "COM selection" menu
 - Select the "CAN" line and press Enter
5. Press the X key to return to the Bios menu
6. Select the "Start up mode" menu
 - Select the "Remote application" line and press Enter
7. Press the X key to return to the Bios menu
8. Select the "CAN" menu
 - Select the "Baudrate" line and check that it is 50K
 - Select the "Node ID" line and check that it is 126
9. Press the X key to return to the Bios menu
10. Select the "Application" menu and press Enter.

The display will once again retrieve data from the controller. This process will take about 5 minutes.

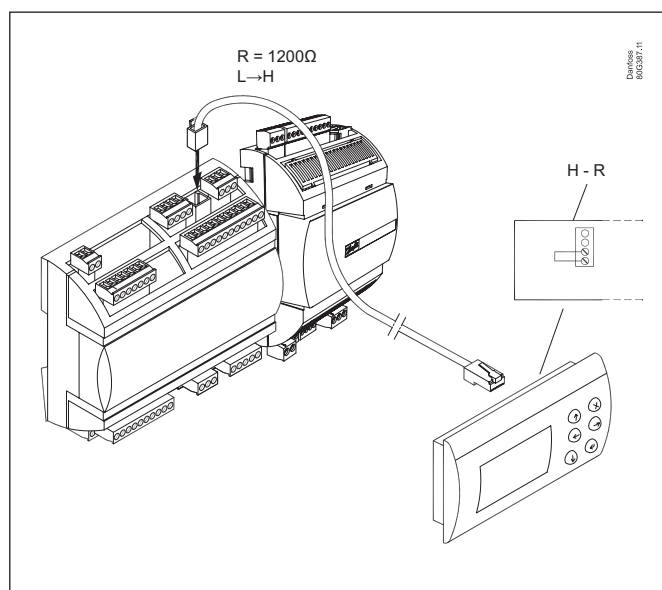

10. Important

Read the following before you connect the controller and the two valve modules to the supply voltage.

The EKE 1P is pre-configured to determine the extension module mode based on the AI4 status of the EKE 1P:

AI4 open circuit: high pressure module with address 96

AI4 short circuit to 5V: receiver module with address 97



If you wish to check the addresses of the two valve modules, you should carry out the following:

Connect all modules to the power supply.

Immediately press on both the "X" and "Enter" buttons while the controller is starting up.

Find the display "CAN SETTINGS" > "ACTIVE NODES"

The two 1-digits represent the addresses 96 (HP module) and 97 (Receiver module) respectively.

If you remove the connection to a valve module, the display of the address will also disappear.

Power failure safety

The EKE 2U can be used as back-up power supply. It will enable the EKE 1P modules to close the high pressure valve and the receiver valve in case of power failure. The wiring is illustrated on page 26. Refer to the EKE 1P and EKE 2U documentation for further details.

MODBUS to Bitzer IQ module CM-RC-01

Communication to Bitzer IQ modules is done through HP extension module via CAN and MODBUS interface. Connected Bitzer IQ modules will be scanned whenever AK-PC 572 powers up or the Main switch has changed state.

Status and alarm information from Bitzer IQ modules are displayed under each suction group, menu item CM-RC status and alarm.

Note: The MODBUS interface on the AK-PC 572 can be used for frontend communication.

MODBUS settings

HP module MODBUS communication is configured to baud rate at 19200 kbps and 8 bits, even parity and 1 stop bit. (19200, 8E1). All Bitzer IQ modules must be configured to the same BUS set-up.

Bitzer IQ modules addresses

MODBUS addresses can be configured under Network for each compressor group.

Default IQ Module MODBUS addresses: MT group is 10 and LT group is 20.

Note: If more than one Bitzer IQ module is connected in the same group, the second address must follow the first address. Example: If the first address in the MT group is 10, then the second must be 11; if the first address in the MT group is 20, then the second must be 21.

Recommended settings for Bitzer IQ

It is recommended to configure "Modbus control timeout function" to "Stop" compressor and "MODBUS control timeout" to 60 s. The AK-PC 572 application monitors MODBUS communication and will generate an alarm and do safety cut-out of a compressor internally when communication has timed out.

MODBUS connection to Bitzer IQ modules:

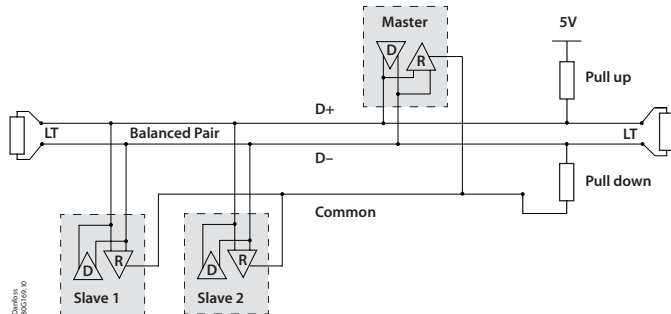

Details about the MODBUS communication can be found in the document "EKD / EIM Data communication Modbus RS 485 RTU design guide".

There must always be two line terminations on the network, one at each BUS end. The line termination can be installed by connecting a 120 Ohm resistor between D+ and D-.

Connection to Bitzer IQ modules

Note: The shield (drain) should only be connected to one of the modules.

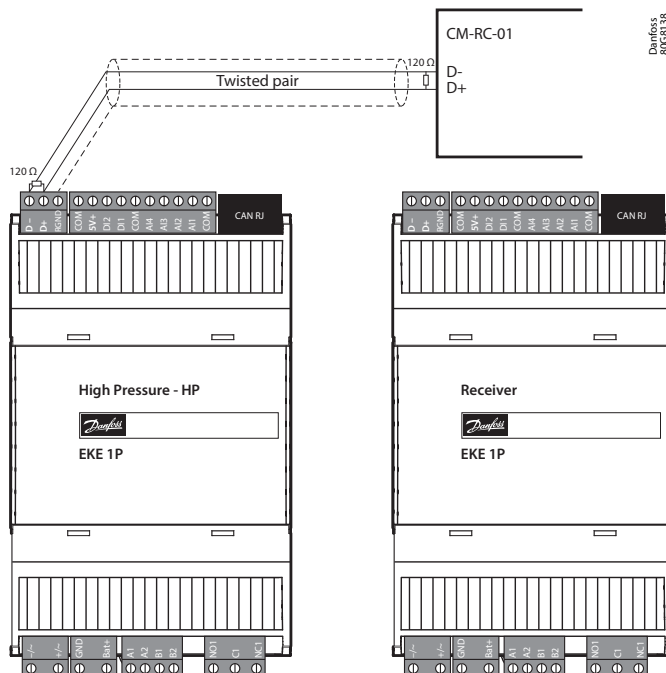

The figure above shows the correct line termination for the RS-485 network. The pull-up and pull-down resistors are integrated in the AK-PC 572.

11. Connections

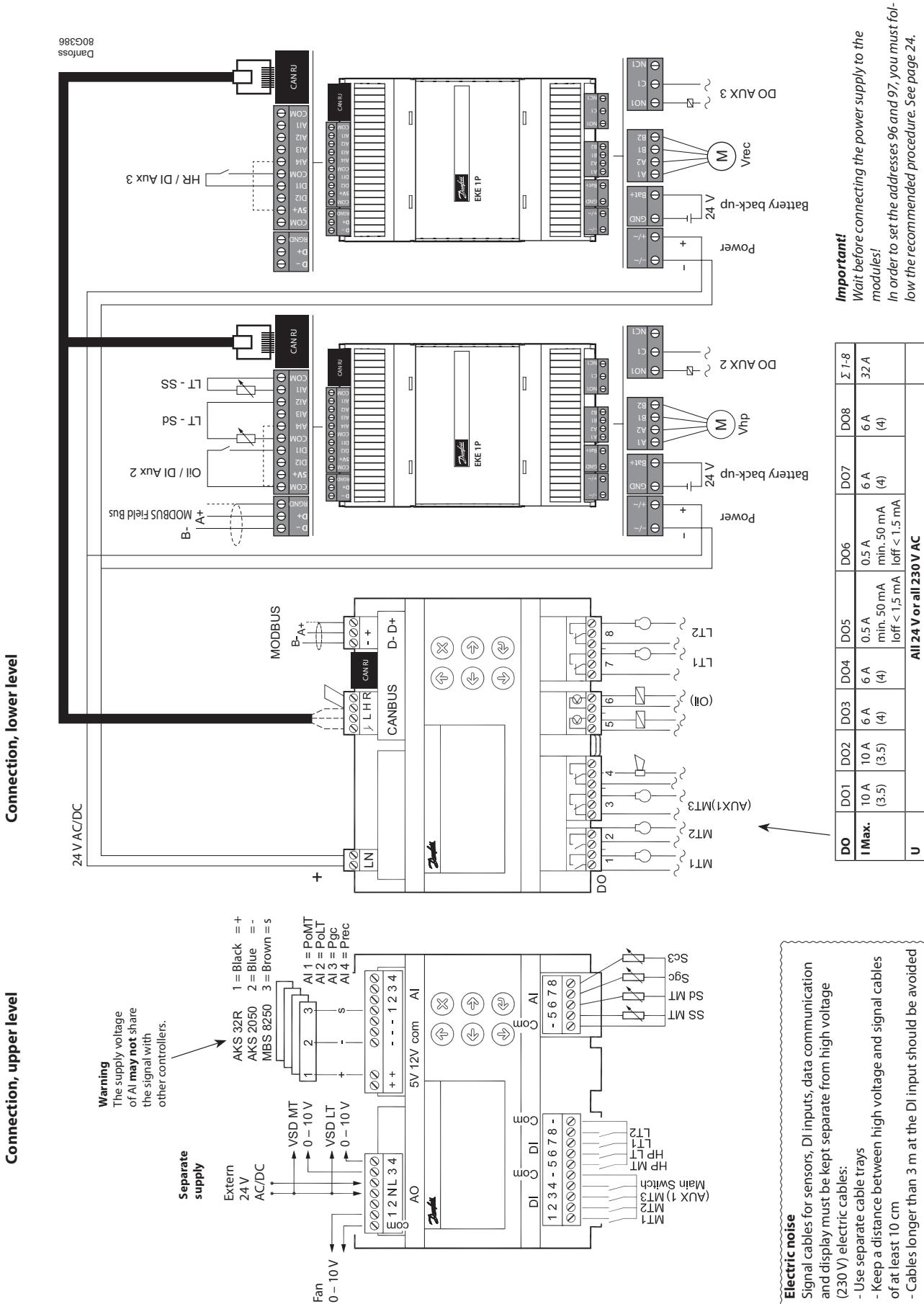

Important!
Wait before connecting the power supply to the modules!
In order to set the addresses 96 and 97, you must follow the recommended procedure. See page 24.

Danfoss 80G386

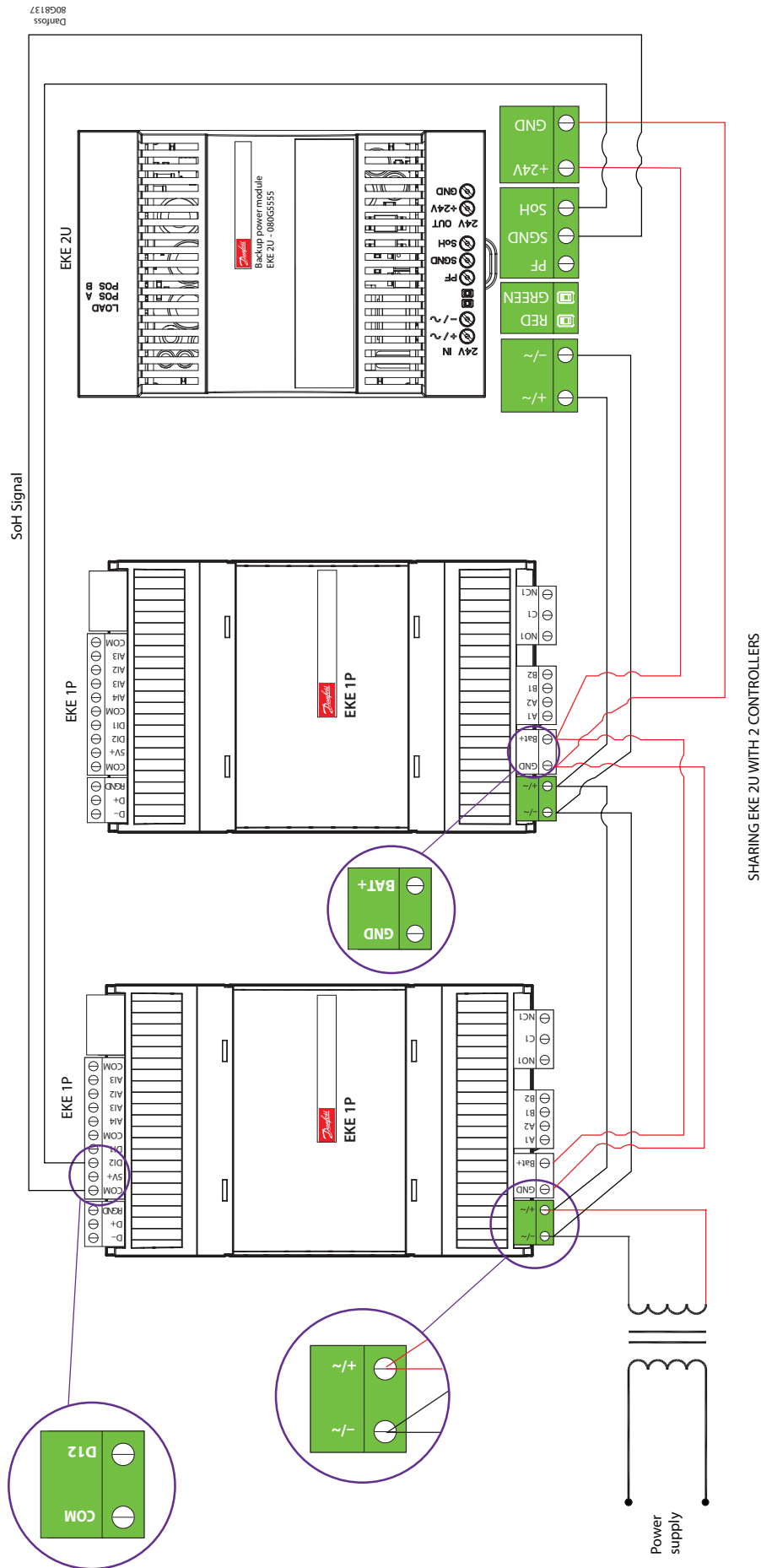

MAIN MODULE

AO - Analogue output, 3 pcs. AO1, AO3, AO4

Must be used if using frequency converters or EC motors.
Connect 24 V on N and L (separate power supply) Avoid earth fault current.

- Use double-insulated transformer. The secondary side must not be earthed.

Obtain 0-10 volts from terminals Com-AO1, N-AO3 and N-AO4.

PAY ATTENTION TO THE POLARITY of N.

(AO3 and AO4 are galvanically isolated. AO1 is not).

AI - Analogue inputs

Pressure transmitters, 4 pcs. AI1 - AI4

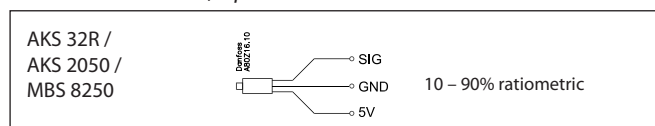

Temperature sensors, 4 pcs. AI5 - AI8

• Pt 1000 ohm, AKS 11 or AKS 21.

DI - Digital switch inputs, 8 pcs. DI1 - DI8

The connection may be a shut-down or interruption function.
Select what is to be activated during configuration.

(DI3 can be used as an AUX1 input, but only if regulated with 2 MT compressors).

Supply

24 V AC or DC Class II is required.

AK-PC 572 17 VA

EKE 1P 20 VA

CANBUS

Communication to the high pressure module and to the receiver module

"L" to "L" and "H" to "H"

A jumper must be connected between "H" and "R".

Terminate on the AK-PC with a resistance of 120 ohm.

If mounting an external display, the termination must also be done at the display. See next page.

Important!

In order to establish communication with the extension modules, you must follow the recommended procedure. See next page.

MODBUS

It is important that the installation of the data communication cable is carried out correctly. See separate literature no. RC8AC...
Remember termination at the termination points.

DO - Digital outputs, 8 pcs. DO1-DO8

DO5 and DO6 are solid state relays. The outputs are used for connecting a Bitzer CR11. If a Bitzer CR11 is not being connected, output DO6 can be used for activation of an oil valve.

The relays are de-rated to the specified values.

The alarm relay will be driven under normal operation and will drop in the event of alarms and insufficient voltage to the controller.

(DO3 can be used as an AUX1 output, but only if regulated with 2 MT compressors).

HIGH PRESSURE MODULE

Supply voltage to high pressure module

The power supply can be taken from the main module.

Battery

Ensure that the valve closes if there is no supply voltage.

Stepper valve

FX ventil type CCMT.

Connector:

A1 5: WHITE

A2 6: BLACK

B1 7: RED

B2 8: GREEN

CANBUS

Data communication to the main module.

Sensor inputs

• Pt 1000 ohm, AKS 11 or AKS 21.

Contact input AUX 2

Signal from oil level,
or input for fan alarm or another alarm.

Relay output AUX 2

Activation of de-superheating or hot gas dump.

MODBUS

Data communication with other devices.

It is important that the installation of the data communication cable is performed correctly.

See separate literature no. RC8AC...

Remember termination at the termination points. Use a twisted pair shielded cable, but do not connect the shield to the EKE 1P.

RECEIVER MODULE

Supply voltage to high pressure module

The power supply can be taken from the main module.

Battery

Ensure that the valve closes if there is no supply voltage.

Stepper valve

FX valve type CCMT.

Connector:

A1 5: WHITE

A2 6: BLACK

B1 7: RED

B2 8: GREEN

CANBUS

Data communication to the main module.

The section must be terminated using a 120 ohm resistor.

Contact input AUX 3

Signal from heat recovery,
or input for fan alarm or another alarm.

Relay output AUX 3

Activation of heat recovery,
or AUX 3 output for de-superheating or hot gas dump.

External display

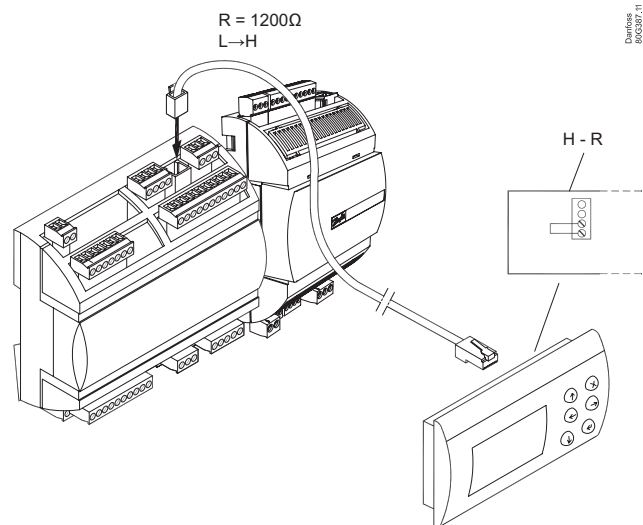

External display

If an external display is connected, it must be connected to the controller using a wire with a plug. See order. Communication will take place via CANBUS. The CANBUS termination must be moved **away** from the controller and to the external display.

Extension modules

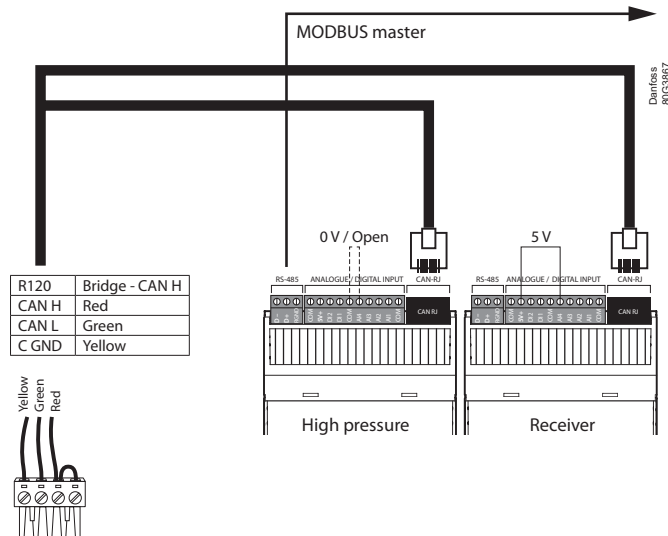

Bitzer CRIL

The pulse signal can also be used to control one of the CRIL with 2 unloaders (4 cylinder version). Compressor capacity can be controlled from 10 to 100% depending on the pulsation of the unloaders. The unloaders are connected to DO5 and DO6. Connect compressor relay to DO-MT1.

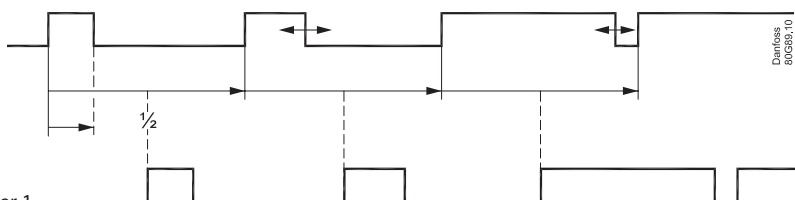
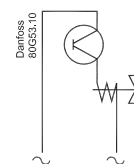

Unloader 2 follows unloader 1 but is offset a 1/2 period.

Injection ON

The electronic expansion valves in the cooling appliances must be closed when all the compressors are prevented from starting. The injection ON function is then switched OFF. As a result, the evaporators will not be filled with fluid that can be led to a compressor when the regulation process restarts.

This function can be achieved through data communication.

Alternatively, wiring must be created using the compressor relays. When all compressors have been stopped, a signal must be issued to the evaporator controls that will subsequently close the expansion valves.

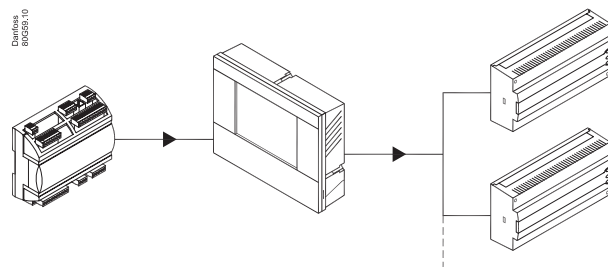

12. Data

| | | |
|----------------------------------|--|--|
| Supply voltage | 24 V AC +/-15% 50/60 Hz, 17 VA 24 V DC (20 – 60 V), 17 VA | |
| 8 analog Input | Pressure measuring: 10 – 90%, ratiometric 1 – 5 C 4 – 20 mA | |
| | Temperature measurement Pt 1000 ohm/0 °C | |
| 8 digital input | From contact function E.g. to: Start/stop of regulation Monitoring of safety circuits General alarm function | |
| Relay output to capacity control | 4 pcs. SPDT (8A) | AC-1: 6 A (ohmic) AC-15: 4 A (inductive) |
| | 2 pcs. SPST (16A) | AC-1: 10 A (ohmic) AC-15: 3,5 (inductive) |
| | 2 pcs. Solid State. PWM for scroll - unload | I _{max.} = 0.5A I _{min.} = 50 mA. Leakage <1.5 mA Not short-circuit protected |
| 3 Voltage output | 0– 10 V DC Ri = 1kohm Separate 24 V supply required | |
| Display output | For type MMIGRS2 | |
| Data communication | MODBUS for AK-SM 800 | |
| | CANBUS for valve control modules and external display | |
| Environments | -20 – 60 °C, during operations | |
| | -40 – 70 °C, during transport | |
| | 20 – 80% Rh, not condensed No shock influence / vibrations | |
| Enclosure | IP 20 | |
| Weight | 0.4 kg | |
| Mounting | DIN-rail | |
| Connection terminals | Max. 2.5 mm ² multi core | |
| Approvals | EU Low Voltage Directive and EMC demands re CE-marking complied with LVD tested acc. EN 60730-1 and EN 60730-2-9 EMC-tested acc. EN61000-6-2 and 3 UL approval | |

Installation considerations

Accidental damage, poor installation, or site conditions, can give rise to malfunctions of the control system, and ultimately lead to a plant breakdown.

Every possible safeguard is incorporated into our products to prevent this. However, a wrong installation, for example, could still present problems. Electronic controls are no substitute for normal, good engineering practice.

Danfoss will not be responsible for any goods, or plant components, damaged as a result of the above defects. It is the installer's responsibility to check the installation thoroughly, and to fit the necessary safety devices.

Special reference is made to the necessity of signals to the controller when the compressor is stopped and to the need of liquid receivers before the compressors.

Your local Danfoss agent will be pleased to assist with further advice, etc.

Pressure transmitter / temperature sensor



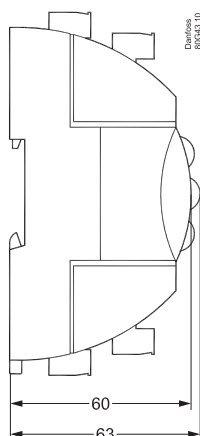
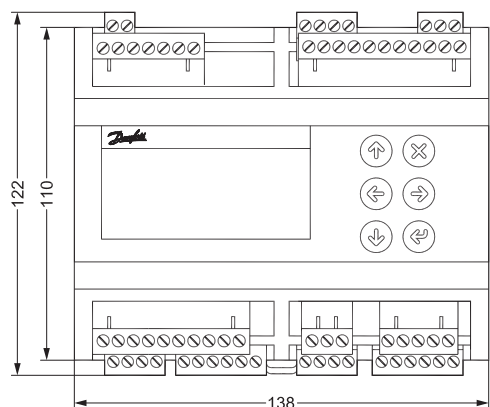

Kindly refer to catalogue RK0YG...

13. Mounting/dimensions



For DIN rail mounting only (IP 20)

14. Ordering

| Type | Function | Operation | | Supply voltage | Code no. |
|-----------|--------------------------------|---|--------------------------|----------------|-----------------|
| AK-PC 572 | Capacity controller |  | With buttons and display | 24 V | 080G0320 |
| EKE 1P | Stepper Valve Extension Module |  | Via AK-PC or MMIGRS2 | 24 V | 080G0325 |
| EKE 2U | Back-up power module |  | | 24 V | 080G5555 |
| MMIGRS2 | Display unit |  | With buttons and display | - | 080G0294 |
| | Wire for display unit |  | L = 1.5 m, 1 pcs. | | 080G0075 |
| | | | L = 3 m, 1 pcs | | 080G0076 |

List of literature

Installation guide for extended operation RC8AC
 Here you can see how a data communication connection to
 ADAP-KOOL® Refrigeration control systems can be established.

ENGINEERING
TOMORROW

