



Data sheet

Differential pressure controller with flow limitation (PN 16, 25, 40)

AFPB / VFQ 2(1) – return mounting, adjustable setting

AFPB-F / VFQ 2(1) – return mounting, fixed setting

Description



The controller has a control valve with adjustable flow restrictor, an actuator with one control diaphragm and spring for differential pressure setting.

- Further on two valve versions are available:
- VFQ 2 with metallic sealing cone
 - VFQ 21 with soft sealing cone (on special request)

Main data:

- DN 15-125
- k_{vs} 4.0-160 m³/h
- Flow range: 0.05-120 m³/h
- PN 16, 25, 40
- Setting range: 0.1-0.7 bar/0.15-1.5 bar
- Temperature:
 - Circulation water/glycolic water up to 30 %: 2 ... 150/200 °C
- Connections:
 - Flange

The controller is a self-acting differential pressure controller with flow limitation primarily for use in district heating systems. The controller closes on rising differential pressure or when set max. flow is exceeded.

Ordering

Example 1:
Differential pressure controller with flow limitation; return mounting; DN 15; k_{vs} 4.0; PN 16; metallic sealing; setting range 0.1-0.7 bar; t_{max} 150 °C; flange;

- 1x VFQ 2 DN 15 valve
Code no: ..
- 1x AFPB actuator
Code no: ..
- 1x AFPB DN 15 impulse tube
Code no: ..
- 1x Impulse tube set AF
Code no: ..

VFQ 2 Valves (metallic sealing cone)

Picture	DN (mm)	k_{vs} (m ³ /h)	Connections	T_{max} (°C)	Code No.	T_{max} (°C)	Code No.	
					PN 16		PN 25	PN 40
	15	4.0	Flanges acc. to EN 1092-1	150	065B2654	200 ¹⁾	065B2667	065B2677
	20	6.3			065B2655		065B2668	065B2678
	25	8.0			065B2656		065B2669	065B2679
	32	16			065B2657		065B2670	065B2680
	40	20			065B2658		065B2671	065B2681
	50	32			065B2659		065B2672	065B2682
	65	50			065B2660		065B2673	065B2683
	80	80			065B2661		065B2674	065B2684
	100	125			065B2662		065B2675	065B2685
	125	160			065B2663		065B2676	065B2686

¹⁾ Note: other valves available on special request.
¹⁾ At temperatures above 150 °C only with seal pots (see Accessories)

Products will be delivered separately.

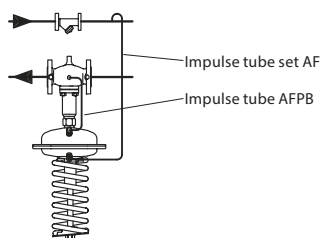

Ordering (continuous)

Example 2:
Differential pressure controller with flow limitation; return mounting; DN 15; k_{vs} 4.0; PN 25; metallic sealing; setting range 0.1-0.7 bar; t_{max} 200 °C; flange;

- 1x VFQ 2 DN 15 valve
Code no: **065B2667**
- 1x AFPB actuator
Code no: **003G1017**
- 1x AFPB DN 15 impulse tube
Code no: **003G1355**
- 1x Impulse tube set AF
Code no: **003G1391**
- 1x Seal pot V1
Code no: **003G1392**

Products will be delivered separately.

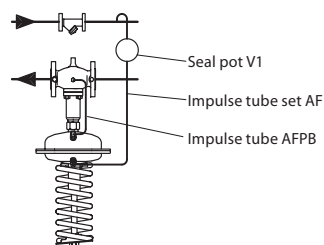

AFPB(-F) Actuators

Picture	Δp setting range (bar)	Max. operat. pressure	Code No.
	0.1 – 0.7	25	003G1017
	0.15 – 1.5		003G1016
	0.2	25	003G1026
	0.5		003G1027

Accessories

Picture	Type designation	For controller	DN (mm)	PN	Code No.
	Impulse tubes (Stainless steel)	AFPB	15	16, 25, 40	003G1355
			20		003G1357
			25		
			32		003G1359
			40		
			50		
			65		003G1361
			80		
			100		003G1363
125	003G1364				
Picture	Type designation	Description	Ordering number	Code No.	
	Impulse tube set AF	- 1x Copper tube $\varnothing 10 \times 1 \times 1500$ mm - 1 x compression fitting for imp. tube connection to pipe (G 1/4) - 2 x socket	-	003G1391	
	Seal pot V1 ¹⁾	Capacity 1 liter; with compression fittings for imp. tube $\varnothing 10$	-	003G1392	
	Compression fitting ²⁾	For impulse tube $\varnothing 10$ connections to controller	G 1/4	003G1468	
	Combination piece KF3	For combination with pressure actuators. Electrical actuator connected on side (port B) only for ON/OFF function	G 1 1/4/2x G 1 1/4	003G1441	
	Combination piece KF2	For combination with thermostat-side connection to port B		003G1440	
	Shut off valve	For impulse tube $\varnothing 10$	-	003G1401	
	Throttle valve			065B2909	

¹⁾ Seal pot has to be used on impulse tubes always when $T_{max} \geq 150$ °C

²⁾ Consist of a nipple, compression ring and nut

³⁾ Port A - for connection of any type of actuator

Service kits

Picture	Type designation	For valve	DN (mm)	k_{vs} (m ³ /h)	Code No.
	Valve insert	VFQ 2	15	4.0	065B2796
			20	6.3	065B2797
			25	8	065B2798
			32	16	
			40	20	065B2799
			50	32	
			65	50	065B2800
			80	80	
			100	125	065B2801
125	160				
	Stuffing cone (with EPDM O-rings)				003G1464

Technical data

Valve

Nominal diameter					DN	15	20	25	32	40	50	65	80	100	125
k _{VS} value					m ³ /h	4.0	6.3	8.0	16	20	32	50	80	125	160
Range of max. flow setting ¹⁾	Δp _{SP}	Δp _{SYSTEM}	Δp _b												
			0.1/0.2/0.5	from		0.05	0.15	0.25	0.4	0.6	0.9	2	3.5	6.5	11
	0.2	0.1	0.1	to	m ³ /h	1.4	2.1	2.5	5	6.5	10	16	25	40	50
	0.5	0.3	0.2	to		2	3	4	7	11	16	28	40	63	80
1.0	0.5	0.5	to		3	4.5	6	10	16	24	40	58	90	120	
Cavitation factor z						0.6	0.6	0.6	0.55	0.55	0.5	0.5	0.45	0.4	0.35
Leakage acc. to standard IEC 534 (% of k _{VS})					VFQ 2	≤ 0.03									
					VFQ 21	≤ 0.01									
Nominal pressure					PN	16, 25, 40									
Min. differential pressure						see remark ²⁾									
Max. differential pressure					PN 16	16									15
					PN 25, 40	20									
Media					Circulation water/glycolic water up to 30 %										
Media pH					Min. 7, max. 10										
Media temperature					VFQ 2	2 ... 150/2 ... 200 ³⁾									
					VFQ 21	2 ... 150									
Connections					Flange										
Materials															
Valve body					PN 16	Grey cast iron EN-GJL-250 (GG-25)									
					PN 25	Ductile iron EN-GJS-400(GGG-40.3)									
					PN 40	Cast steel GP240GH (GS-C 25)									
Valve seat					Stainless steel, mat. No. 1.4021										
Valve cone					Stainless steel, mat. No. 1.4404										
Sealing					VFQ 2	Metal									
					VFQ 21	EPDM									
Pressure relieve system					Bellows (Stainless steel, mat. No. 1.4571)										

¹⁾ Max. flow rate depends on the differential pressure over the system (dp System). System is part of the application where differential pressure is controlled by AFPB(-F) and for this part the resistance is well known/defined.
Flow rates in table are specified for 3 different situations.

$$\Delta p_{SP} = \Delta p_{SYSTEM} + \Delta p_b$$

Δp_{SP} - differential pressure set point

Δp_{SYSTEM} - system differential pressure

Δp_b - differential pressure over flow restrictor

²⁾ Depends on the flow rate and valve k_{VS}; For Q_{set} = Q_{max} -> Δp_{min} ≥ 0.5 bar; For Q_{set} < Q_{max} -> Δp_{min} = $\left(\frac{Q}{k_{VS}}\right)^2 + \Delta p_b$

³⁾ at temperatures above 150 °C only with seal pots (see Accessories)

Actuator

Type		AFPB		AFPB-F	
Actuator size	cm ²	250			
Max. operational pressure	PN	25			
Diff. pressure setting ranges and spring colours	bar	0.1-0.7	0.15-1.5	0.2	0.5
		yellow	red	fixed setting	
Materials					
Actuator housing		Steel, mat. No.1.0338, zinc plated			
Control diaphragm		EPDM (Rolling; fibre enforced)			

Application principles

AFPB controller must be installed in the return pipe only.

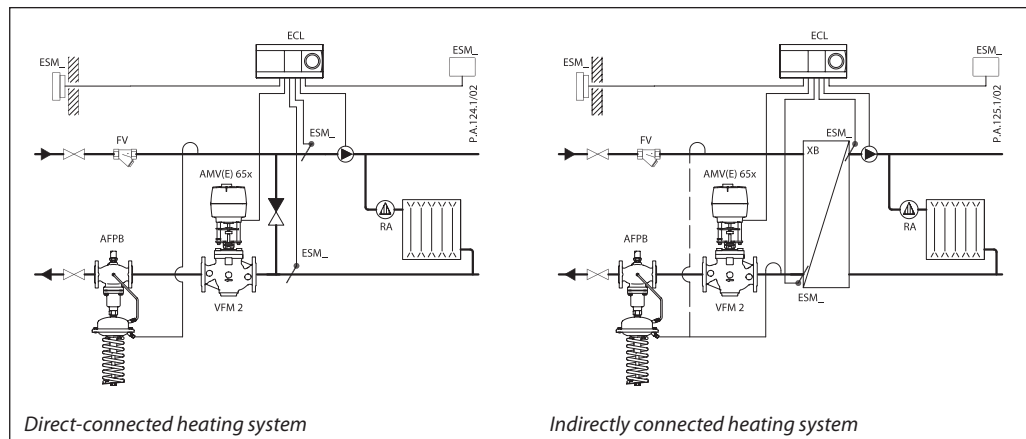

Combinations

Example:
Differential pressure and temperature controller with flow limitation; return mounting; DN 15; k_{vs} 4.0; PN 16; metallic sealing; setting range 0.1-0.7 bar; t_{max} 150 °C; flange;

- 1x VFQ 2 DN 15 valve
Code no: **065B2654**
- 1x AFPB actuator
Code no: **003G1017**
- 2x Impulse tube set AF
Code no: **003G1391**
- 1x AFT06 thermostat
Code no: **065-4390**
- 1x Combination piece KF2
Code no: **003G1440**

Products will be delivered separately.

Note:
For AFT 06 thermostat data see relevant data sheet

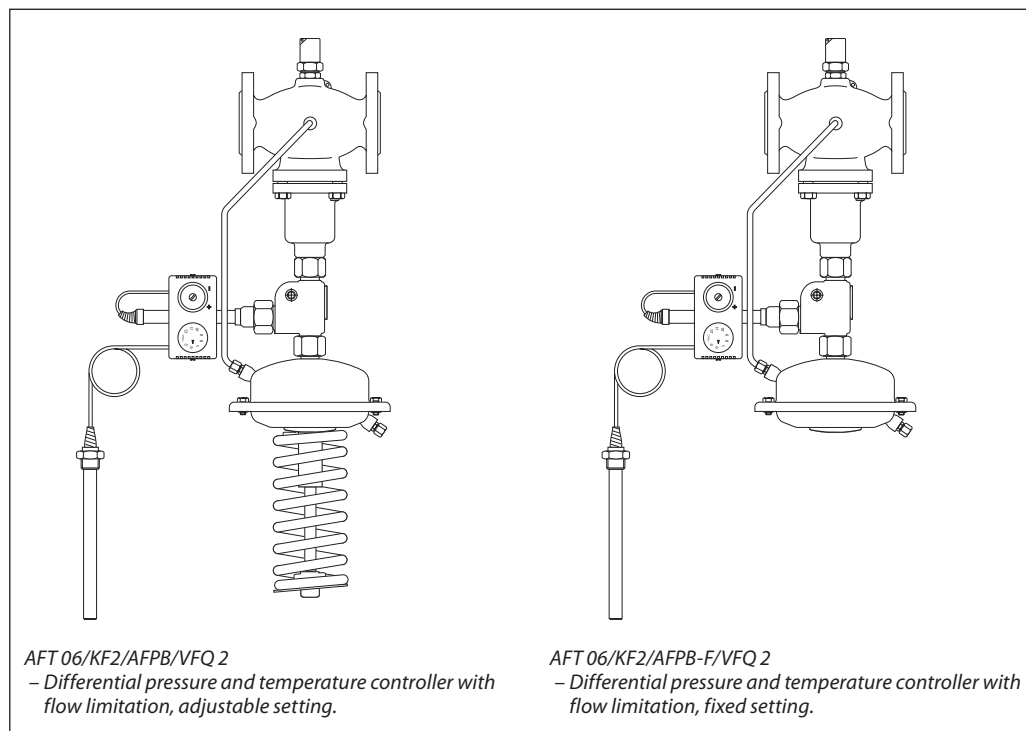

AFT 06/KF2/AFP-B/VFQ 2
- Differential pressure and temperature controller with flow limitation, adjustable setting.

AFT 06/KF2/AFP-F/VFQ 2
- Differential pressure and temperature controller with flow limitation, fixed setting.

Installation positions

DN 15-80 $T_{max} \leq 120$ °C
The controllers can be installed in any position.

DN 15-80 $T_{max} > 120$ °C; DN 100-125
The controllers can be installed in horizontal pipes only, with a pressure actuator oriented downwards.

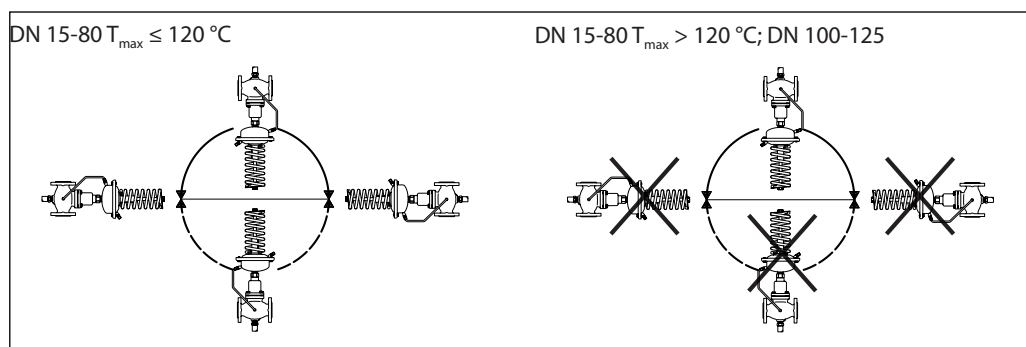

Pressure temperature diagram

Working area is below P-T line and it ends at Tmax for each valve

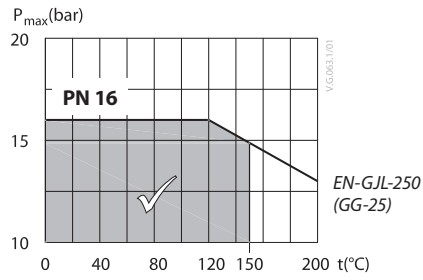

Maximum allowed operating pressure as a function of media temperature (according to EN 1092-2)

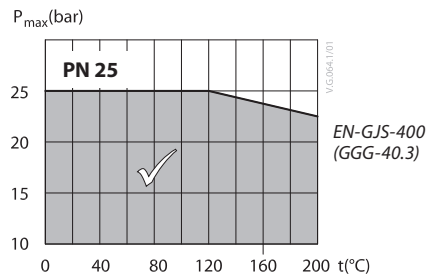

Maximum allowed operating pressure as a function of media temperature (according to EN 1092-2)

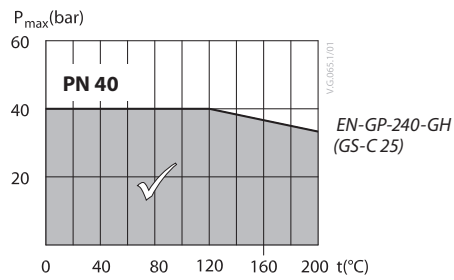

Maximum allowed operating pressure as a function of media temperature (according to EN 1092-1)

Sizing

– Directly connected heating system

Example 1

Motorised control valve (MCV) for mixing circuit in direct-connected heating system requires differential pressure of 0.3 bar (30 kPa) and flow less than 1800 l/h.

k_v value is calculated according to formula:

$$k_v = \frac{Q_{max}}{\sqrt{\Delta p_{AFPB} - \Delta p_b}} = \frac{1.8}{\sqrt{0.4 - 0.1}}$$

$$k_v = 3.3 \text{ m}^3/\text{h}$$

Solution:

The example selects AFPB/VFQ DN 15; k_{vs} value 4.0; with differential pressure setting range 0.1-0.7 bar; flow setting range 0.05-1.4 m³/h.

Given data:

- Q_{max} = 1.8 m³/h (1800 l/h)
- Δp_{min} = 0.7 bar (70 kPa)
- $\Delta p_{circuit}^{1)}$ = 0.1 bar (10 kPa)
- Δp_{MCV} = 0.3 bar (30 kPa) selected
- $\Delta p_b^{2)}$ = 0.1 bar (10 kPa) assumption

Remark:

- ¹⁾ $\Delta p_{circuit}$ corresponds to the required pump pressure in the heating circuit and is not to be considered when sizing the AFPB.
- ²⁾ Δp_b is differential pressure over flow restrictor.

The differential pressure set value is:

$$\Delta p_{set \text{ value}} = \Delta p_b + \Delta p_{MCV} = 0.1 + 0.3$$

$$\Delta p_{set \text{ value}} = 0.4 \text{ bar (40 kPa)}$$

The total pressure loss across the controller is:

$$\Delta p_{AFPB} = \Delta p_{min} - \Delta p_{MCV} = 0.7 - 0.3$$

$$\Delta p_{AFPB} = 0.4 \text{ bar (40 kPa)}$$

If other differential pressure is assumed than $\Delta p_b = 0.1$ bar, in order to maintain the k_{vs} value, the flow has to be adjusted using the flow restrictor screw. The new set value (Q-setting) of the assumed differential pressure ($\Delta p_{b \text{ NEW}} = 0.2$ bar) is calculated according to formula:

$$Q_{setting} = \frac{\sqrt{\Delta p_b}}{\sqrt{\Delta p_{b \text{ NEW}}}} \times Q_{max}$$

Possible pipe pressure losses in tubes, shut-off fittings, heatmeters, etc. are not included.

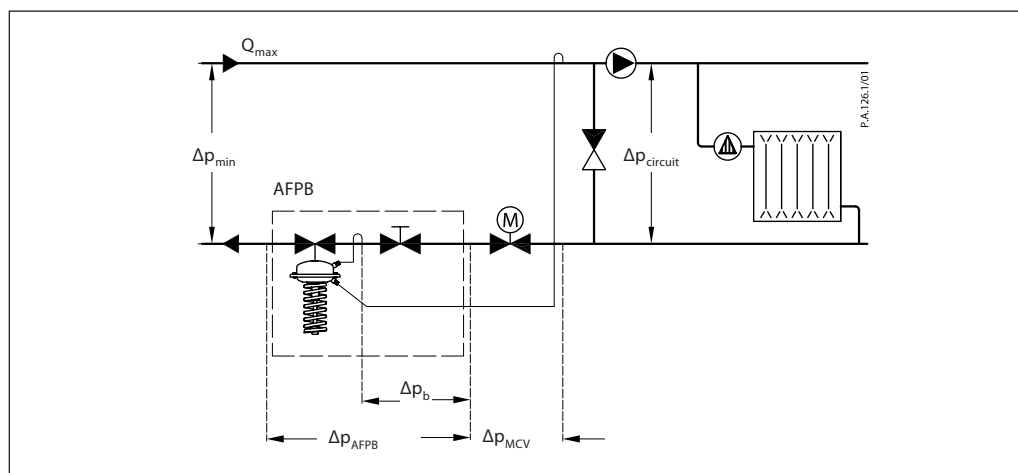

Sizing (continuous)

- Indirectly connected heating system

Example 2

Motorised control valve (MCV) for indirectly connected heating system requires differential pressure of 0.3 (30 kPa) bar and flow less than 1300 l/h.

Given data:

- Q_{max} = 1.3 m³/h (1300 l/h)
- Δp_{min} = 1.0 bar (100 kPa)
- $\Delta p_{exchanger}$ = 0.05 bar (5 kPa)
- Δp_{MCV} = 0.3 bar (30 kPa) selected
- $\Delta p_b^{1)}$ = 0.2 bar (20 kPa) assumption

Remark:

¹⁾ Δp_b is differential pressure over flow restrictor

The differential pressure set value is:

$$\begin{aligned} \Delta p_{set\ value} &= \Delta p_b + \Delta p_{exchanger} + \Delta p_{MCV} \\ \Delta p_{set\ value} &= 0.2 + 0.05 + 0.3 \\ \Delta p_{set\ value} &= 0.55\ \text{bar}\ (55\ \text{kPa}) \end{aligned}$$

The total pressure loss across the controller is:

$$\begin{aligned} \Delta p_{AFPB} &= \Delta p_{min} - \Delta p_{exchanger} - \Delta p_{MCV} \\ \Delta p_{AFPB} &= 1.0 - 0.05 - 0.3 \\ \Delta p_{AFPB} &= 0.65\ \text{bar}\ (65\ \text{kPa}) \end{aligned}$$

Possible pipe pressure losses in tubes, shut-off fittings, heatmeters, etc. are not included.

k_v value is calculated according to formula:

$$k_v = \frac{Q_{max}}{\sqrt{\Delta p_{AFPB} - \Delta p_b}} = \frac{1.3}{\sqrt{0.65 - 0.2}}$$

$$k_v = 1.9\ \text{m}^3/\text{h}$$

Solution:

The example selects AFPB/VFQ 2 DN 15; k_{vS} value 4.0; with differential pressure setting range 0.1-0.7 bar; flow setting range 0.05-2.0 m³/h.

If other differential pressure is assumed than $\Delta p_b = 0.2$ bar, in order to maintain the k_{vS} value, the flow has to be adjusted using the flow restrictor screw. The new set value (Q-setting) of the assumed differential pressure ($\Delta p_{bNEW} = 0.1$ bar) is calculated according to formula:

$$Q_{setting} = \frac{\sqrt{\Delta p_b}}{\sqrt{\Delta p_{bNEW}}} \times Q_{max}$$

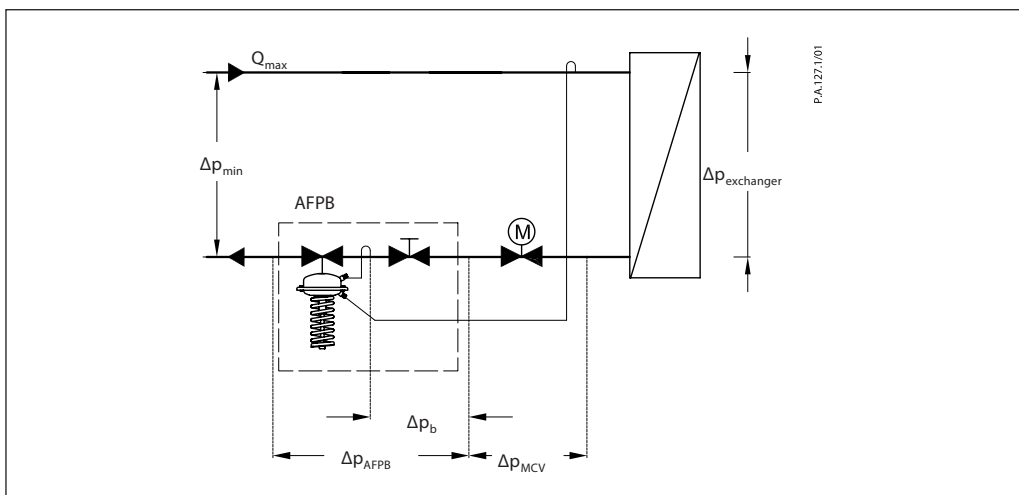

Design

1. Valve body
2. Cover
3. Adjustable flow restrictor
4. Valve seat
5. Valve insert
6. Pressure relieved valve cone
7. Valve stem
8. Bellows for pressure relief of valve cone
9. Actuator
10. Control diaphragm for differential pressure and flow control
11. Excess pressure safety valve
12. Built in spring for differential pressure and flow control
13. Setting spring for diff. pressure control
14. Adjuster for diff. pressure setting, prepared for sealing
15. Stuffing cone
16. Union nut
17. Impulse tube
18. Compression fitting for impulse tube
19. Upper casing of diaphragm
20. Lower casing of diaphragm

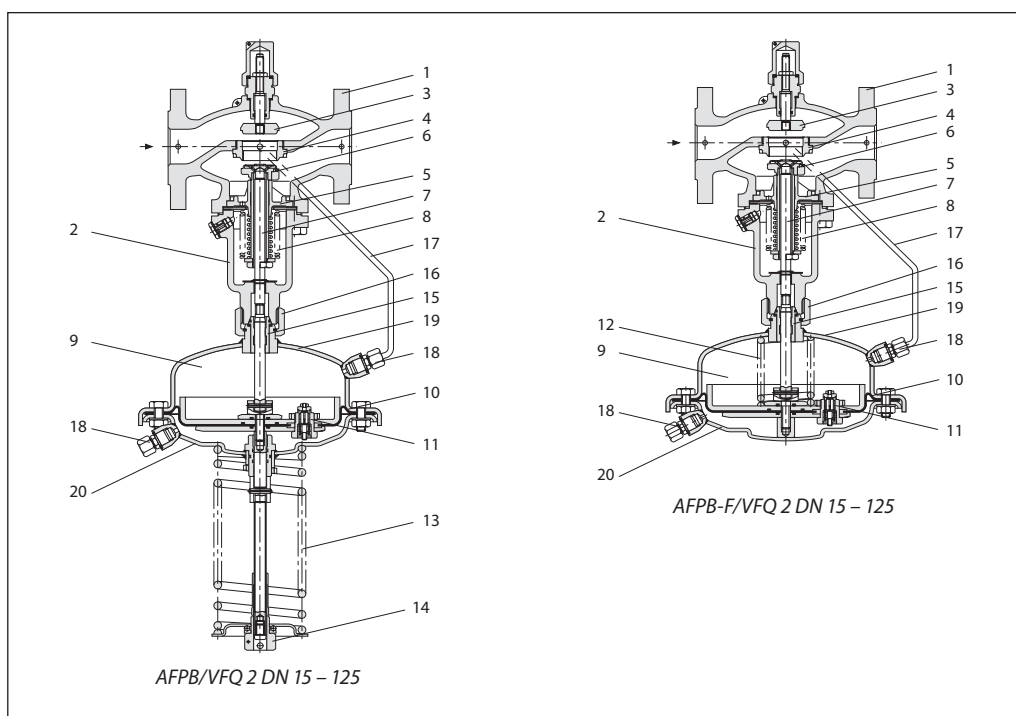

Function

Pressure changes from flow and return pipes are being transferred through the impulse tubes to the actuator chambers and act on control diaphragm for diff. pressure and flow control. The diff. pressure is controlled by means of setting spring for diff. pressure control. Control valve closes on rising differential pressure and opens on falling differential pressure to maintain constant differential pressure. Flow volume is limited by means of the flow restrictor.

Controller is equipped with excess pressure safety valve, which protects control diaphragm for diff. pressure and flow control from too high differential pressure.

Settings

Flow setting

Flow setting is being done by the adjustment of the flow restrictor position. The adjustment can be performed on the basis of flow adjustment diagram (see relevant instructions) and/or by the means of heat meter.

Differential pressure setting

Differential pressure setting is being done by the adjustment of the setting spring for diff. pressure control. The adjustment can be done by means of adjuster for diff. pressure setting and pressure indicators.

Dimensions

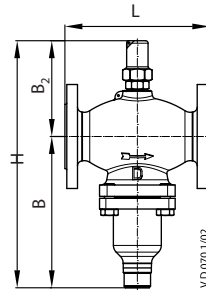

VFQ DN 15-125

VFQ 2, VFQ 21 Valves

DN		15	20	25	32	40	50	65	80	100	125	
L		130	150	160	180	200	230	290	310	350	400	
B	mm	213	213	239	239	241	241	276	276	381	381	
B ₂		124	124	135	135	152	152	164	164	194	194	
H		337	337	374	374	393	393	440	440	575	575	
Weight	PN 16/25	kg	8	9	10.5	12.5	15.5	18.5	28.5	31	61	71
	PN 40								31	34	63	72

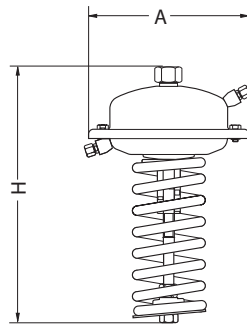

AFPB Actuator

Actuator size	cm ²	250
Ø A	mm	263
H	mm	457
Weight	kg	9

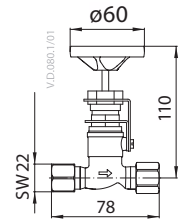

Shut off valve

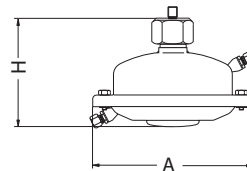

AFPB-F Actuator

Actuator size	cm ²	250
Ø A	mm	263
H	mm	160
Weight	kg	9

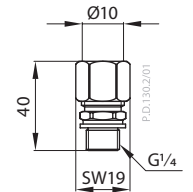

Compression fitting

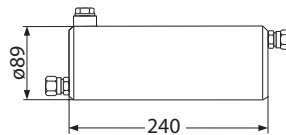

Seal pot V1

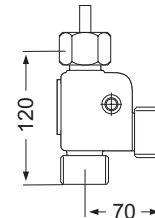

Comb. piece KF2, KF3



Danfoss A/S

Heating Segment • heating.danfoss.com • +45 7488 2222 • E-Mail: heating@danfoss.com

Danfoss can accept no responsibility for possible errors in catalogues, brochures and other printed material. Danfoss reserves the right to alter its products without notice. This also applies to products already on order provided that such alterations can be made without subsequential changes being necessary in specifications already agreed. All trademarks in this material are property of the respective companies. Danfoss and all Danfoss logotypes are trademarks of Danfoss A/S. All rights reserved.
