

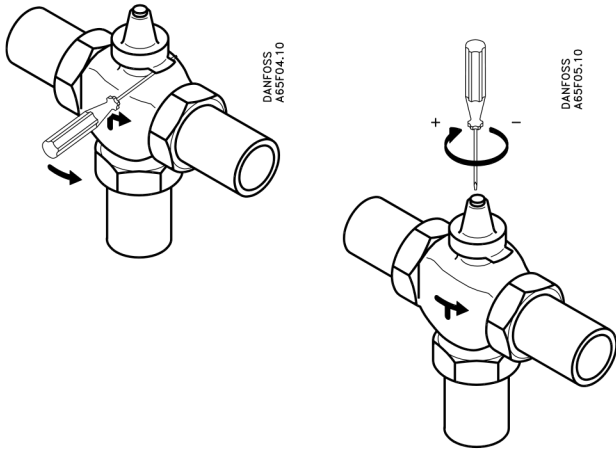

## Installation Guide

### VMV



| Type   | Max. Δp<br>bar |
|--------|----------------|
| VMV 15 | 0,6            |
| VMV 20 | 0,5            |
| VMV 25 | 0,3            |
| VMV 32 | 0,2            |
| VMV 40 | 0,2            |

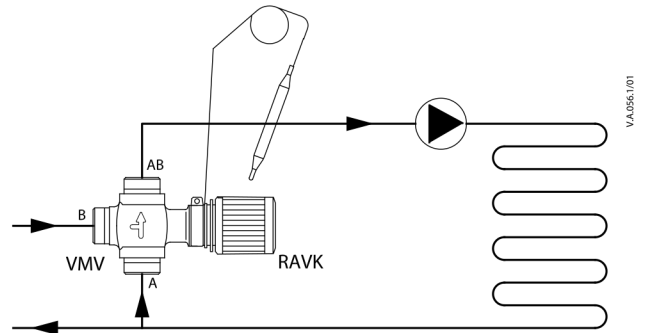
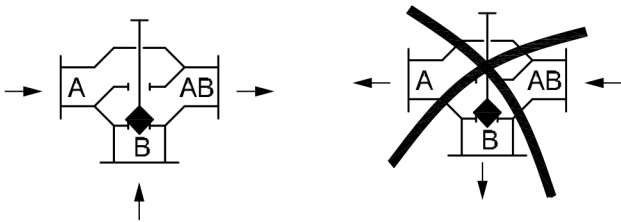
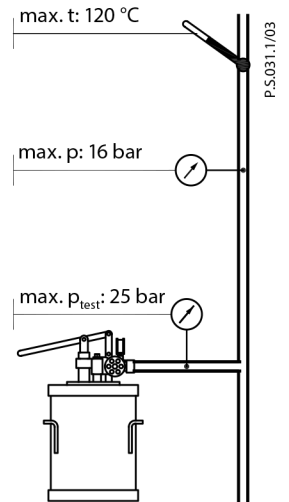

**NC (normally closed)**  
RAVK (only VMV DN 15, 20)  
ABV-NC

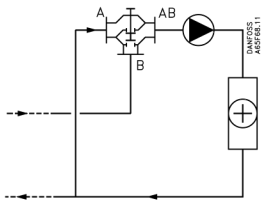

**NC (normally closed)**  
RAVK (only VMV DN 15, 20)  
ABV-NC

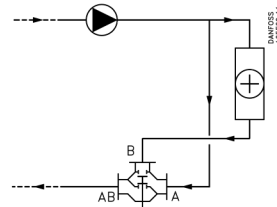

**NO (normally open)**  
ABV-NO

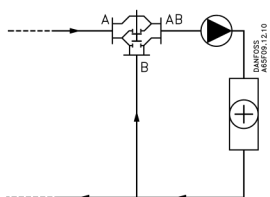

**NO (normally open)**  
ABV-NO

