

User Guide

Superheat controller

EKC 315A



The controller and valve can be used where there are requirements to accurate control of superheat and temperature in connection with refrigeration.

E.g.:

- Cold store (air coolers)
- Processing plant (water chillers)
- A/C plant

Advantages

- The evaporator is charged optimally – even when there are great variations of load and suction pressure.
- Energy savings – the adaptive regulation of the refrigerant injection ensures optimum utilisation of the evaporator and hence a high suction pressure.
- Exact temperature control – the combination of adaptive evaporator and temperature control ensures great temperature accuracy for the media.
- The superheating is regulated to the lowest possible value at the same time as the media temperature is controlled by the thermostat function.

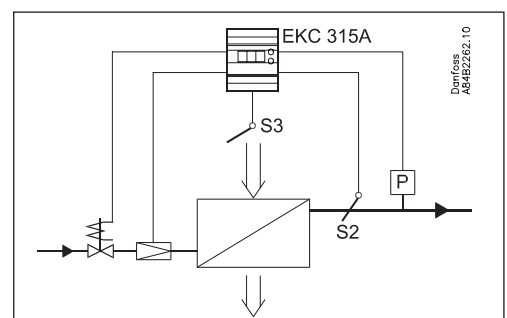

Introduction

Functions

- Regulation of superheat
- Temperature control
- MOP function
- ON/OFF input for start/stop of regulation
- Input signal that can displace the superheat reference or the temperature reference
- Alarm if the set alarm limits are exceeded
- Relay output for solenoid valve
- PID regulation
- Output signal following the temperature showing in the display

System

The superheat in the evaporator is controlled by one pressure transmitter P and one temperature sensor S2.

The valve can be one of the following types:

- ICM
- AKV (AKVA)

ICM is an electronically, directly run engine valve, controlled by an ICAD type actuator. It is used with a solenoid valve in the liquid line.

TQ valve

The controller can also control a TQ type valve. This valve has been discontinued from the product range, but the settings are still described in this manual.

AKV is a pulsating valve.

Where the AKV valve is used it also functions as solenoid valve. Temperature control is performed based on a signal from temperature sensor S3 which is placed in the air current before the evaporator. Temperature control is in the shape of an ON/OFF thermostat that shuts off the liquid flow in the liquid line.

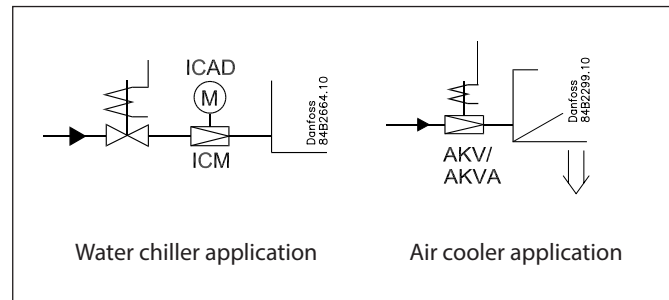

Operation

Superheat function

You may choose between two kinds of superheat, either:

- Adaptive superheat or
- Load-defined superheat

MOP

The MOP function limits the valve's opening degree as long as the evaporating pressure is higher than the set MOP value.

Override function

Via the analog input a displacement can be made of the temperature reference or of the superheat reference. The signal can either be a 0-20 mA signal or a 4-20 mA signal. The reference can be displaced in positive or negative direction.

External start/stop of regulation

The controller can be started and stopped externally via a contact function connected to input terminals 1 and 2. Regulation is stopped when the connection is interrupted. The function must be used when the compressor is stopped. The controller then closes the solenoid valve so that the evaporator is not charged with refrigerant.

Relays

The relay for the solenoid valve will operate when refrigeration is required. The relay for the alarm function works in such a way that the contact is cut-in in alarm situations and when the controller is de-energised.

Modulating/pulsating expansion valve

In 1:1 systems (one evaporator, one compressor and one condenser) with small refrigerant charge ICM is recommended.

In a system with an AKV valve the capacity can be distributed by up to three valves if slave modules are mounted. The controller will displace the opening time of the AKV valves, so that they will not pulsate at the same time.

Used as slave module is a controller of the type EKC 347.

Analog output

The controller is provided with an analog current output which can be set to either 0-20 mA or 4-20 mA. The signal will either follow the superheat, opening degree of the valve or the air temperature.

When an ICM valve is in use, the signal is used for control of the valve via the ICAD actuator.

PC operation

The controller can be provided with data communication so that it can be connected to other products in the range of ADAP-KOOL® refrigeration controls. In this way operation, monitoring and data collection can be performed from one PC – either on the spot or in a service company.

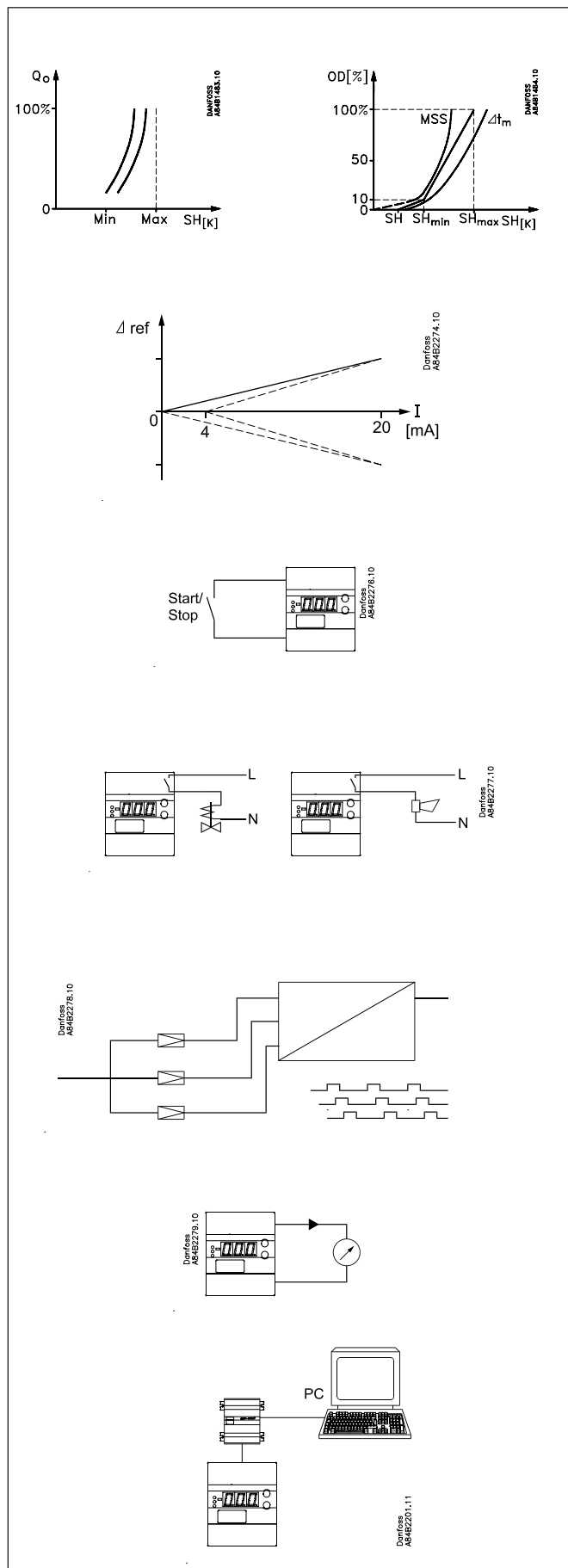

Survey of functions

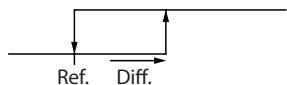
Function	Parameter	Parameter by operation via data communication
Normal display		
Normally the superheat is shown (but the valve's opening degree or air temperature may also be selected. See o17).		SH / OD% / S3 temp
Reference		
Se point Regulation is performed based on the set value provided that there is no external contribution (o10). (Push both buttons simultaneously to set the setpoint).	-	TempSetpoint.
Differential When the temperature is higher than the reference plus the set differential, the solenoid valve's relay will be activated. It will become deactivated when the temperature drops below the set reference. 	r01	Differential
Unit Here you select whether the controller is to indicate the temperature values in °C or in °F. If indication in °F is selected, other temperature settings will also change over to Fahrenheit, either as absolute values or as delta values The combination of temperature unit and pressure unit is depicted to the right.	r05	Units 0: °C + bar 1: °F + psig (in AKM only °C + bar – is displayed – whatever the setting).
External contribution to the reference This setting determines how large a contribution is to be added to the set setpoint when the input signal is max. (20 mA). See o10.	r06	ExtRefOffset
Correction of signal from S2 (Compensation possibility through long sensor cable).	r09	Adjust S2
Correction of signal from S3 (Compensation possibility through long sensor cable).	r10	Adjust S3
Start/stop of refrigeration With this setting refrigeration can be started and stopped. Start/stop of refrigeration can also be accomplished with the external switch function. See also appendix 1.	r12	Main Switch
Define thermostat function 0: No thermostat function. Only the superheat is regulated 1: Thermostat function as well as regulation of superheat.	r14	Therm. Mode
Alarm		
The controller can give alarm in different situations. When there is an alarm all the light-emitting diodes (LED) will flash on the controller front panel, and the alarm relay will cut in.		
Alarm for upper deviation The alarm for too high S3 temperature is set here. The value is set in Kelvin. The alarm becomes active when the S3 temperature exceeds the actual reference plus A01. (The actual reference can be seen in u28).	A01	Hgh.TempAlrm
Alarm for lower deviation The alarm for too low S3 temperature is set here. The value is set in Kelvin. The alarm becomes active when the S3 temperature drops below the actual reference minus A02.	A02	Low.TempAlrm
Alarm delay If one of the two limit values is exceeded, a timer function will commence. The alarm will not become active until the set time delay has been passed. The time delay is set in minutes.	A03	TempAlrmDel
		With data communication the importance of the individual alarms can be defined. Setting is carried out in the "Alarm destinations" menu.

Control parameters		
P: Amplification factor Kp If the Kp value is reduced the regulation becomes slower.	n04	Kp factor
I: Integration time Tn If the Tn value is increased the regulation becomes slower	n05	Tn sec.
D: Differentiation time Td The D-setting can be cancelled by setting the value to min. (0.)	n06	Td sec.
Max. value for the superheat reference	n09	Max SH
Min. value for the superheat reference Warning! Due to the risk of liquid flow the setting should not be lower than approx. 2-4 K.	n10	Min SH
MOP If no MOP function is required, select pos. Off.	n11	MOP (Bar) (A value of 60 bar corresponds to Off)
AKV valve's time period in seconds Should only be set to a lower value if it is a decentralised plant and the suction pressure fluctuates a lot and in line with the opening of the AKV valve.	n13	AKV per. time
Stability factor for regulation of superheat With a higher value the control function will allow a greater fluctuation of the superheat before the reference is changed. The value should only be changed by specially trained staff.	n18	Stability
Damping of amplification near reference value This setting damps the normal amplification Kp, but only just around the reference value. A setting of 0.5 will reduce the KP value by half. The value should only be changed by specially trained staff.	n19	Kp Min
Amplification factor for the superheat (only in 1:1 plant) This setting determines the ICM or AKV valve's opening degree as a function of the change in evaporating pressure. An increase of the evaporating pressure will result in a reduced opening degree. When there is a drop-out on the low-pressure thermostat during start-up the value must be raised a bit. If there is pending during start-up the value must be reduced a little. The value should only be changed by specially trained staff.	n20	Kp T0
Definition of superheat regulation (Ref. appendix 6) 1: Lowest permissible superheat (MSS). Adaptive regulation. 2: Load-defined superheat. The reference is established based on the line formed by the three points: n09, n10 and n22.	n21	SH mode
Value of min. superheat reference for loads under 10% (The value must be smaller than "n10").	n22	SH Close
Standby temperature when valve closed (TQ only) The TQ actuator is kept warm when the valve reaches its closing point. As the closing point cannot be defined completely accurately due to tolerances and pressure variations, the setting can be changed, as required (how "tightly"/securely the valve is to close). See also appendices 1 and 5.	n26	TQ Kmin
Standby temperature when valve open (TQ only) The TQ actuator's temperature is kept low when the valve reaches its fully open position. Here you set how many degrees the temperature is to be above the expected open temperature in completely open position. The greater the value, the surer it is that the valve will be open, but it will also react more slowly when it has to close again.	n27	TQ Kmax
Max. opening degree The ICM or AKV valve's opening degree can be limited. The value is set in %. The value should only be changed by specially trained staff.	n32	OD Max
Min. opening degree The ICM or AKV valve's opening degree can be set to a specified min. value, disabling full closure. The value should only be changed by specially trained staff.	n33	OD Min

Miscellaneous		
<p>Address If the controller is built into a network with data communication, it must have an address, and the master gateway of the data communication must then know this address. These settings can only be made when a data communication module has been mounted in the controller and the installation of the data communication cable has been completed. This installation is mentioned in a separate document "RC8AC"</p>		Following installation of a data communication module, the controller can be operated on a par with the other controllers in ADAP-KOOL® refrigeration controls.
The address is set between 0 and 119	o03	-
The address is sent to the gateway when the menu is set in pos. ON (The setting will automatically change back to Off after a few seconds.)	o04	-
<p>Valve and output signal Define here the valve that is to regulate and the current signal to be transmitted to the analog output "AO". The current signal will show the superheat if o17=1. Or opening degree of the valve, if o17=2. Or the S3 temperature if o17=3 0:Off 1: TQ valve and 0-20 mA 2: TQ valve and 4-20 mA 3: AKV valve and 0-20 mA 4: AKV valve and 4-20 mA 5: AKV valve and signal for another controller. See appendix 3. 6: ICM and ICM OD% /0-20 mA 7: ICM and ICM OD% /4-20 mA</p>	o09	Valve/AO type
<p>Input signal for reference displacement Definition of function and signal range. 0: No signal 1: Displacement of temperature reference with 0-20 mA 2: Displacement of temperature reference with 4-20 mA 3: Displacement of superheat reference with 0-20 mA 4: Displacement of superheat reference with 4-20 mA (4 or 0 mA will not give a displacement. 20 mA will displace the reference by the value set in menu r06)</p>	o10	AI A type
<p>Frequency Set the net frequency.</p>	o12	50 / 60 Hz (50=0, 60=1)
<p>Select signal for showing display Here you can select the signal to be shown in the normal display. The signal is also transmitted to the analog output. See O09. 1: Superheat 2: Valve's opening degree 3: Air temperature (If you during operation give the lower button a brief push, you can see the following: The S3 temperature, if 1 has been selected. The superheat, if 2 has been selected. Temperature reference if 3 has been selected).</p>	o17	Display mode
<p>Manual control of outputs For service purposes the individual relay outputs and the AKV/A output can be forced into position ON. However only when regulation has been stopped. OFF: No override 1: Relay to the solenoid valve is ON. 2: AKV/A output is ON. 3: Alarm relay is activated (connection established between terminals 12 and 13).</p>	o18	-
<p>Working range for pressure transmitter Depending on the application a pressure transmitter with a given working range is used. This working range (say, -1 to 12 bar) must be set in the controller. The min. value is set.</p>	o20	MinTrans Pres.
The max. value is set	o21	Max TransPres.
<p>(Setting for the function o09 and only if the valve is TQ or AKV) Set the temperature value or opening degree of the valve where the output signal must be minimum (0 or 4 mA)</p>	o27	AO min. value
<p>(Setting for the function o09 and only if the valve is TQ or AKV) Set the temperature value or opening degree of the valve where the output signal must be maximum (20 mA). (With a temperature range of 50 K (differential between the settings in o27 and o28) the dissolution will be better than 0.1 K. With 100 K the dissolution will be better than 0.2 K.)</p>	o28	AO max. value

Refrigerant setting Before refrigeration can be started, the refrigerant must be defined. You can select the following refrigerants: 1=R12. 2=R22. 3=R134a. 4=R502. 5=R717. 6=R13. 7=R13b1. 8=R23. 9=R500. 10=R503. 11=R114. 12=R142b. 13=User defined. 14=R32. 15=R227. 16=R401A. 17=R507. 18=R402A. 19=R404A. 20=R407C. 21=R407A. 22=R407B. 23=R410A. 24=R170. 25=R290. 26=R600. 27=R600a. 28=R744. 29=R1270. 30=R417A. 31=R422A. 32=R413A. 33=R422D. 34=R427A. 35=R438A (Warning: Wrong selection of refrigerant may cause damage to the compressor).	o30	Refrigerant
Service		
A number of controller values can be printed for use in a service situation		
Read valve's actuator temperature (TQ)	u04	Actuator temp.
Read reference for valve's actuator temperature (TQ)	u05	Actuator Ref.
Read value of external current signal (AIA)	u06	AI A mA
Read value of transmitted current signal	u08	AO mA
Read status of input DI (start/stop input)	u10	DI
Read the ongoing cutin time for the thermostat or the duration of the last completed cutin	u18	Ther. RunTime
Read the temperature at the S2 sensor	u20	S2 temp.
Read superheat	u21	SH
Read the control's actual superheat reference	u22	SH ref.
Read the valve's opening degree	u24	OD%
Read evaporating pressure	u25	Evap. pres. Pe
Read evaporating temperature	u26	Evap. temp Te
Read the temperature at the S3 sensor	u27	S3 temp.
Read control reference (Set setpoint + any contribution from external signal)	u28	Temp. ref
Read value of current signal from pressure transmitter (AIB)	u29	AI B mA
	--	DO1 Alarm Read status of alarm relay
	--	DO2 Liq. Valv Read status of relay for solenoid valve
Operating status		
The controller's operating status can be called forth by a brief (1s) activation of the upper button. If a status code exists it will be shown. (Status codes have lower priority than alarm codes. This means that status codes cannot be seen if there is an active alarm code. The individual status codes have the following meanings:		EKC State (0 = regulation)
S10: Refrigeration stopped by the internal or external start/ stop.		10
S11: Thermostat is cutout		11

Operation

Display

The values will be shown with three digits, and with a setting you can determine whether the temperature are to be shown in °C or in °F.

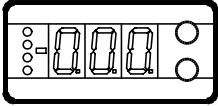

Light-emitting diodes (LED) on front panel

There are LED's on the front panel which will light up when the belonging relay is activated.

The upper LED will indicate the valve's opening degree. A short pulse indicates a small liquid flow and a long pulse a heavy liquid flow. The other LED will indicate when the controller calls for refrigeration.

The three lowermost LED's will flash, if there is an error in the regulation.

In this situation you can upload the error code on the display and cancel the alarm by giving the uppermost button a brief push.

The buttons

When you want to change a setting, the two buttons will give you a higher or lower value depending on the button you are pushing. But before you change the value, you must have access to the menu. You obtain this by pushing the upper button for a couple of seconds - you will then enter the column with parameter codes. Find the parameter code you want to change and push the two buttons simultaneously. When you have changed the value, save the new value by once more pushing the two buttons simultaneously.

- Gives access to the menu (or cutout an alarm)
- Gives access to changes
- Saves a change

Examples of operations

Set set-point

1. Push the two buttons simultaneously
2. Push one of the buttons and select the new value
3. Push both buttons again to conclude the setting

Set one of the other menus

1. Push the upper button until a parameter is shown
2. Push one of the buttons and find the parameter you want to change
3. Push both buttons simultaneously until the parameter value is shown
4. Push one of the buttons and select the new value
5. Push both buttons again to conclude the setting

Menu survey

SW = 1.4x

Function	Parameter	Min.	Max.	Factory setting
Normal display				
Shows the actual superheat/ valve's opening degree/ temperature	-		K	
Define view in o17				
Temperature, superheating, or the temp. reference is displayed if the bottom button is pressed briefly.	-		%	
Define view in o17				
Reference				
Set the required set point	-	-60°C	50°C	10
Differential	r01	0.1 K	20 K	2.0
Units (0=°C+bar /1=°F+psig)	r05	0	1	0
External contribution to the reference	r06	-50 K	50 K	0
Correction of signal from S2	r09	-50.0 K	50.0 K	0.0
Correction of signal from S3	r10	-50.0 K	50.0 K	0.0
Start / stop of refrigeration	r12	OFF	On	0
Define thermostat function (0= no thermostat function, 1=On/off thermostat)	r14	0	1	0
Alarm				
Upper deviation (above the temperature setting)	A01	3.0 K	20 K	5.0
Lower deviation (below the temperature setting)	A02	1 K	10 K	3.0
Alarm's time delay	A03	0 min.	90 min.	30
Regulating parameters				
P: Amplification factor Kp	n04	0.5	20	3.0
I: Integration time T	n05	30 s	600 s	120
D: Differentiation time Td (0 = off)	n06	0 s	90 s	0
Max. value of superheat reference	n09	2 K	50 K	6
Min. value of superheat reference	n10	1 K	12 K	4
MOP (max = off)	n11	0.0 bar	60 bar	60
Period time (only when AKV/A valve is used)	n13	3 s	10 s	6
Stability factor for superheat control. Changes should only be made by trained staff	n18	0	10	5
Damping of amplification around reference value Changes should only be made by trained staff	n19	0.2	1.0	0.3
Amplification factor for superheat Changes should only be made by trained staff	n20	0.0	10.0	0.4
Definition of superheat control 1=MSS, 2=LOADAP	n21	1	2	1
Value of min. superheat reference for loads under 10%	n22	1	15	2
Standby temperature when valve closed (TQ valve only) Changes should only be made by trained staff	n26	0 K	20 K	0
Standby temperature when valve open (TQ valve only) Changes should only be made by trained staff	n27	-15 K	70 K	20
Max. opening degree Changes should only be made by trained staff	n32	0	100	100
Min. opening degree Changes should only be made by trained staff	n33	0	100	0
Miscellaneous				
Controller's address	o03*	0	119	-
ON/OFF switch (service-pin message)	o04*	-	-	-
Define valve and output signal: 0: Off 1: TQ, AO: 0-20 mA 2: TQ, AO: 4-20 mA 3: AKV, AO: 0-20 m 4: AKV, AO: 4-20 mA 5: AKV, AO: EKC 347-SLAVE 6: ICM, AO: 0-20 mA / ICM OD% 7: ICM, AO: 4-20 mA / ICM OD%	o09	0	7	0

Define input signal on the analog input AIA: 0: no signal, 1: Temperature setpoint. 0-20 mA 2: Temperature setpoint. 4-20 mA 3: Displacement of superheat reference. 0-20 mA 4: Displacement of superheat reference. 4-20 mA	o10	0	4	0
Set supply voltage frequency	o12	50 Hz	60 Hz	0
Select display for "normal picture" (Display the item indicated in parenthesis by briefly pressing the bottom button) 1: Superheat (Temperature) 2: Valve's opening degree (Superheat) 3: Air temperature (Temperature reference)	o17	1	3	1
Manual control of outputs: OFF: no manual control 1: Relay for solenoid valve: select ON 2: AKV/A output: select ON 3: Alarm relay activated (cut out)	o18	off	3	Off
Working range for pressure transmitter – min. value	o20	-1 bar	60 bar	-1.0
Working range for pressure transmitter – max. value	o21	-1 bar	60 bar	12
(Setting for the function o09, only AKV and TQ) Set the temperature value or opening degree where the output signal must be minimum (0 or 4 mA)	o27	-70°C	160°C	-35
(Setting for the function o09, only AKV and TQ) Set the temperature value or opening degree where the output signal must be maximum (20 mA)	o28	-70°C	160°C	15
Refrigerant setting 1=R12. 2=R22. 3=R134a. 4=R502. 5=R717. 6=R13. 7=R13b1. 8=R23. 9=R500. 10=R503. 11=R114. 12=R142b. 13=User defined. 14=R32. 15=R227. 16=R401A. 17=R507. 18=R402A. 19=R404A. 20=R407C. 21=R407A. 22=R407B. 23=R410A. 24=R170. 25=R290. 26=R600. 27=R600a. 28=R744. 29=R1270. 30=R417A. 31=R422A. 32=R413A. 33=R422D. 34=R427A. 35=R438A	o30	0	35	0
Service				
TQ valve's actuator temperature	u04			°C
Reference of the valve's actuator temperature	u05			°C
Analog input AIA (18-19)	u06			mA
Analog output AO (2-5)	u08			mA
Read status of input DI	u10			on/off
Thermostat cut-in time	u18			min.
Temperature at S2 sensor	u20			°C
Superheat	u21			K
Superheat reference	u22			K
Read AKV valve's opening degree	u24			%
Read evaporating pressure	u25			bar
Read evaporating temperature	u26			°C
Temperature at S3 sensor	u27			°C
Temperature reference	u28			°C
Read signal at pressure transmitter input	u29			mA

*) This setting will only be possible if a data communication module has been installed in the controller.

Factory setting

If you need to return to the factory-set values, it can be done in this way:

- Cut out the supply voltage to the controller
- Keep both buttons depressed at the same time as you reconnect the supply voltage

The controller can give the following messages:		
E1	Error message	Fault in controller
E11		Valve's actuator temperature outside its range
E15		Cut-out S2 sensor
E16		Shortcircuited S2 sensor
E17		Cut-out S3 sensor
E18		Shortcircuited S3 sensor
E19		The input signal on terminals 18-19 is outside the range.
E20		The input signal on terminals 14-15 is outside the range (P0 signal)
A1	Alarm message	High-temperature alarm
A2		Low-temperature alarm
A11		No refrigerant has been selected

Data

Supply voltage	24 V a.c. +/-15% 50/60 Hz, (80 VA) (the supply voltage is galvanically separated from the input and output signals)	
Power consumption	Controller	5 VA
	TQ actuator	75 VA
	AKV coil	55 VA
Input signal	Current signal	4-20 mA or 0-20 mA
	Pressure transmitter	4-20 mA from AKS 33
	Digital input from external contact function	
Sensor input	2 pcs. Pt 1000 ohm	
Output signal	Current signal	4-20 mA or 0-20 mA
	Load	Max. 200 ohm
Relay output	1 pcs. SPST	250 V a.c.
Alarm relay	AC-1: 4 A (ohmic)	
	AC-15: 3 A (inductive)	
Actuator	Input (from TQ)	Temperature signal from sensor in the TQ actuator
	Output (AKV, TQ)	Pulsating 24 V a.c. to actuator
	Output ICM mounted on ICM	Current signal 4-20 mA or 0-20 mA
Data communication	Possible to connect a data communication module	
Environments	0 to +55°C, during operations	
	-40 to +70°C, during transport	
	20 - 80% Rh, not condensed	
No shock influence / vibrations		
Enclosure	IP 20	
Weight	300 g	
Mounting	DIN rail	
Display	LED, 3 digits	
Terminals	max. 2.5 mm ² multicore	
Approvals	EU Low Voltage Directive and EMC demands re CE-marking complied with. LVD-tested acc. to EN 60730-1 and EN 60730-2-9 EMC-tested acc. to EN50081-1 and EN 50082-2	

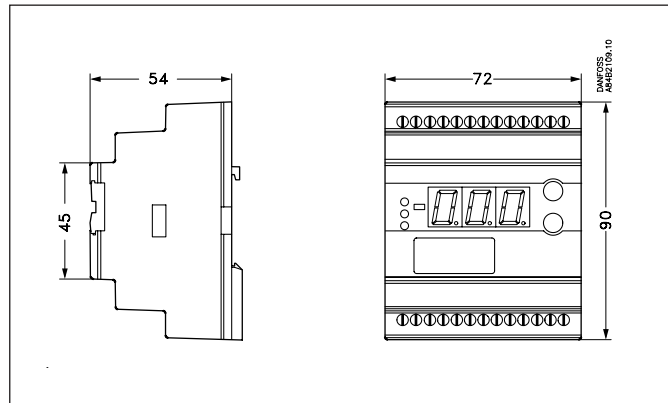

Ordering

Type	Function	Code no.
EKC 315A	Superheat controller	084B7086
EKA 175	Data communication module (accessories), (RS 485 module)	084B7093
EKA 174	Data communication module (accessories), (RS 485 module) with galvanic separation	084B7124

Temperature sensor Pt 1000 ohm / Pressure transmitter type AKS 33 / TQ Valves / AKV valves:Kindly refer to catalogue RK0YG...
ICM/ICAD valves:Kindly refer to DKRCI.PD.HT0.A

Connections

Necessary connections

Terminals:

- 25-26 Supply voltage 24 V a.c.
- 17-18 Only at TQ actuator: Signal from actuator
- 20-21 Pt 1000 sensor at evaporator outlet (S2)
- 14-15 Pressure transmitter type AKS 33
- 9-10 Relay switch for start/stop of solenoid valve
- 1-2 Switch function for start/stop of regulation. If a switch is not connected, terminals 1 and 2 must be shortcircuited.

Application dependent connections

Terminals:

- 21-22 Pt 1000 sensor for measuring air temperature (S3)
- 12-13 Alarm relay
There is connection between 12 and 13 in alarm situations and when the controller is dead
- 18-19 Current signal from other regulation (Ext.Ref.)
- 23-24 Supply to actuator AKV / TQ
- 2-5 Current output for showing superheat or air temperature. Or for signal to a slave module. Or control from ICM valve.
- 3-4 Data communication
Mount only, if a data communication module has been mounted.
It is important that the installation of the data communication cable be done correctly. Cf. separate literature No. RC8AC...

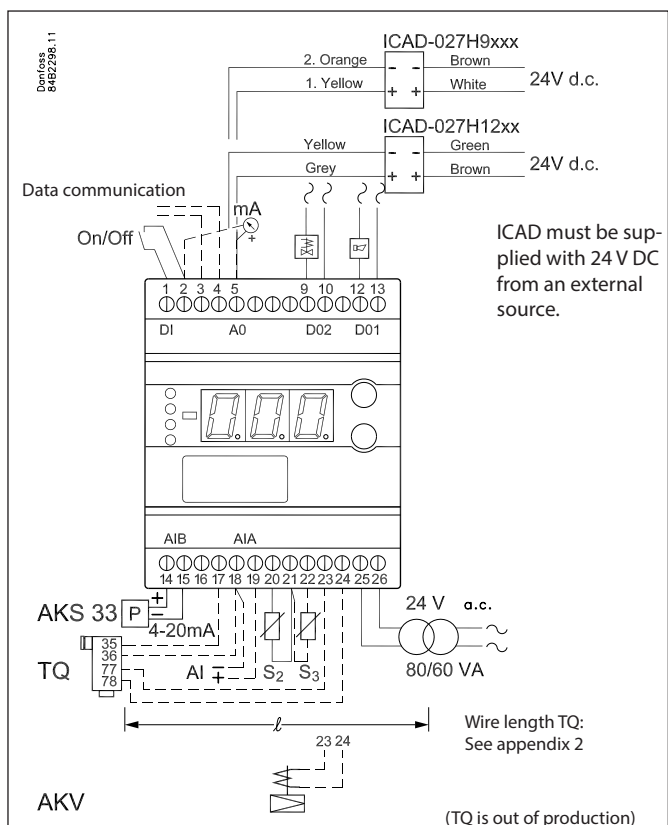

Installation considerations

Accidental damage, poor installation, or site conditions, can give rise to malfunctions of the control system, and ultimately lead to a plant breakdown.

Every possible safeguard is incorporated into our products to prevent this. However, a wrong installation, for example, could still present problems. Electronic controls are no substitute for normal, good engineering practice.

Danfoss will not be responsible for any goods, or plant components, damaged as a result of the above defects. It is the installer's responsibility to check the installation thoroughly, and to fit the necessary safety devices.

Particular attention is drawn to the need for a "force closing" signal to controllers in the event of compressor stoppage, and to the requirement for suction line accumulators.

Your local Danfoss agent will be pleased to assist with further advice, etc.

Appendix 1

Interaction between internal and external start/stop functions and active functions.

Internal Start/stop	Off	Off	On	On
External Start/stop (DI)	Off	On	Off	On
Refrigeration (DO2)	Off			On
TQ actuator	Standby temperature			Regulating
Expansion valve relay	Off			On
Temperature monitoring	No			Yes
Sensor monitoring	Yes			Yes
ICM	Closed			Regulating

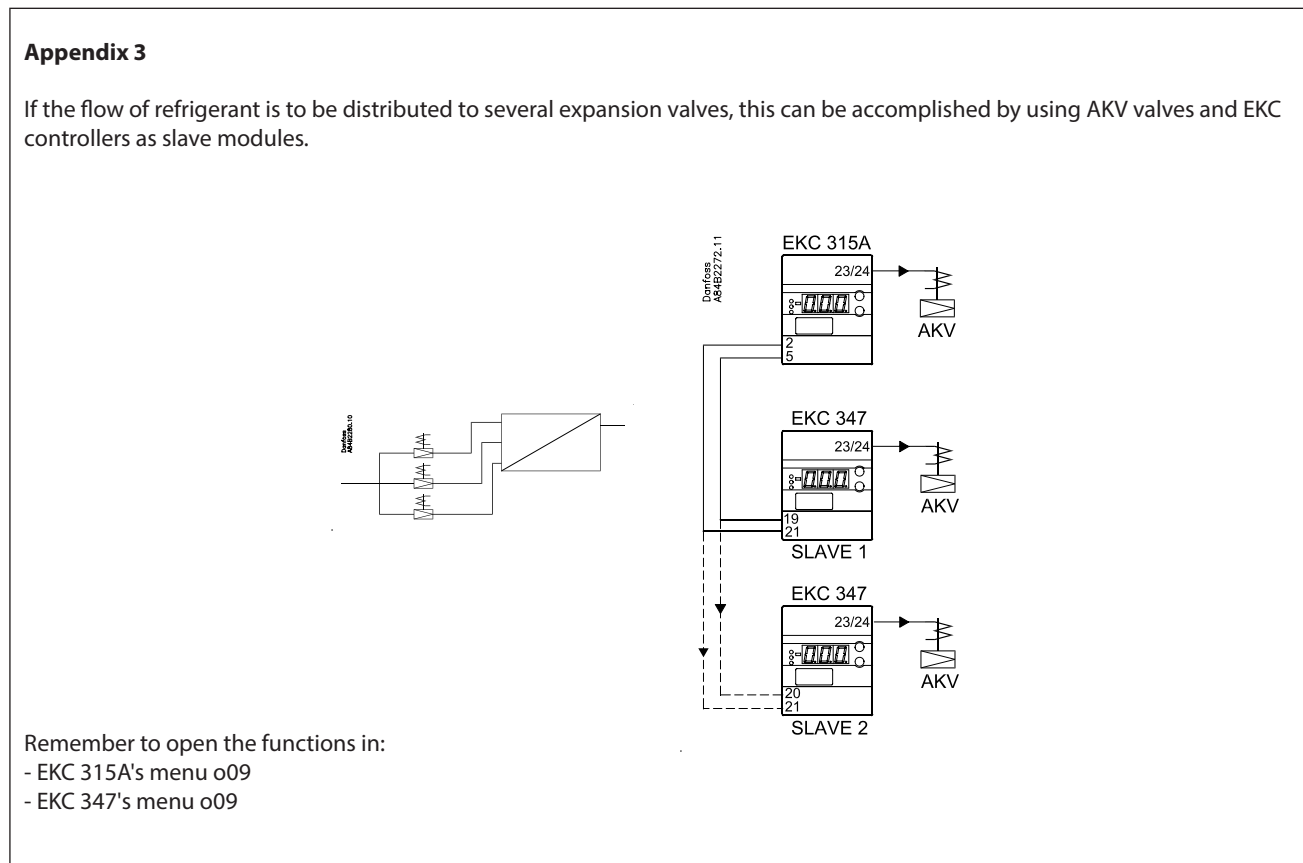
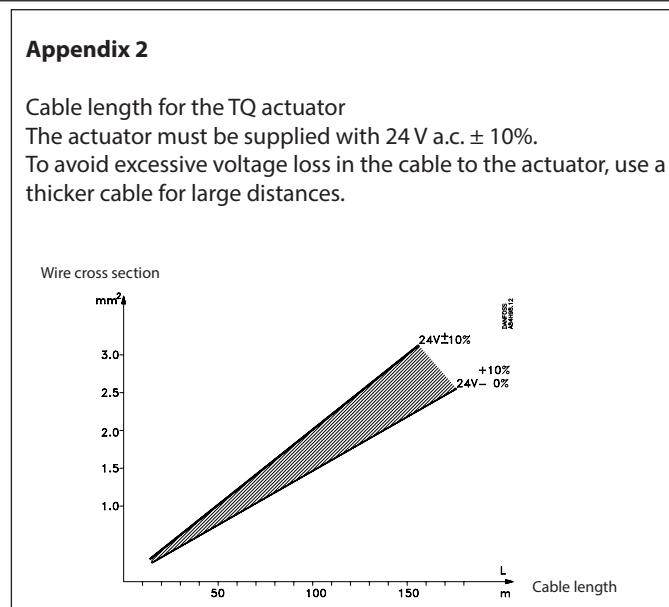

Appendix 5

Standby temperatures for TQ valves.

TQ valve

The valve's actuator temperature is limited, both when regulation is stopped and when the valve is right out at the opening point and closing point.

(The opening and closing points may fluctuate a couple of degrees up or down, depending on pressures and tolerances).

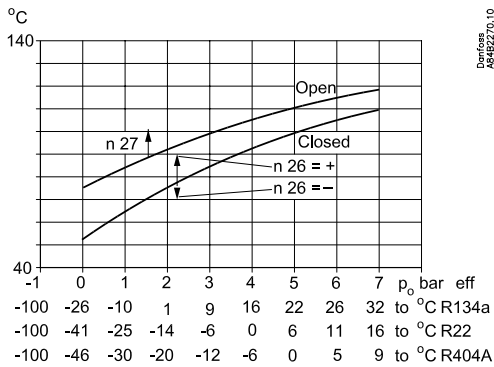

n26

The setting is based on the TQ valve's closing curve. With a plus value the valve can be kept slightly open. With a minus value the valve can be closed completely. If the minus value is high you can be sure that the valve will close, but then it will also react slowly when it has to open again.

n27

This setting defines the number of degrees the actuator has to be warmer when the valve is completely open. If the value is high you can be sure that the valve is completely open, but then it will also react slowly when it has to close again.

Appendix 6

The two types of regulation for superheat are, as follows:

Adaptive superheat

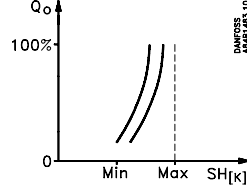

Regulation is here based on the evaporator's load by means of MSS search (MSS = lowest permissible superheat).

(The superheat reference is lowered to the exact point where instability sets in).

The superheat is limited by the settings for min. and max. superheat.

Load-defined superheat

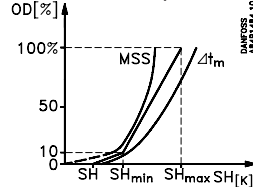

The reference follows a defined curve. This curve is defined by three values: the closing value, the min. value and the max. value. These three values must be selected in such a way that the curve is situated between the MSS curve and the curve for average temperature difference Δt_m (temperature difference between media temperature and evaporating temperature. Setting example = 4, 6 and 10 K).

Start of controller

When the electric wires have been connected to the controller, the following points have to be attended to before the regulation starts:

1. Switch off the external ON/OFF switch that starts and stops the regulation.
2. Follow the menu survey on page 8, and set the various parameters to the required values.
3. Switch on the external switch, and regulation will start.

4. Follow the actual room temperature or superheat on the display.

(On terminals 2 and 5 a current signal can be transmitted which represents the display view. Connect a data collection unit, if applicable, so that the temperature performance can be followed).

If the superheating fluctuates

When the refrigerating system has been made to work steadily, the controller's factory-set control parameters should in most cases provide a stable and relatively fast regulating system.

If the system however fluctuates this may be due to the fact that too low superheat parameters have been selected:

If adaptive superheat has been selected:

Adjust: n09, n10 and n18.

If load-defined superheat has been selected:

Adjust: n09, n10 and n22.

Alternatively it may be due to the fact that the set regulation parameters are not optimal.

If the time of oscillation is longer than the integration time:

($T_p > T_n$, (T_n is, say, 240 seconds))

1. Increase T_n to 1.2 times T_p
2. Wait until the system is in balance again
3. If there is still oscillation, reduce K_p by, say, 20%
4. Wait until the system is in balance
5. If it continues to oscillate, repeat 3 and 4

If the time of oscillation is shorter than the integration time:

($T_p < T_n$, (T_n is, say, 240 seconds))

1. Reduce K_p by, say, 20% of the scale reading
2. Wait until the system is in balance
3. If it continues to oscillate, repeat 1 and 2.

If the superheat has excessive underswing during start-up

If you regulate with valve type ICM or AKV:

Adjust n22 a little bit up and/or n04 a little bit down.

If you regulate with valve type TQ:

Adjust n26 a little bit down

List of literature

Instructions RI8GT (extract from this manual).
Here you can see how controllers are mounted and programmed.

Installation guide for extended operation RC8AC
Here you can see how a data communication connection to ADAP-KOOL® Refrigeration control systems can be established.