

AK-SM 800 IO Offline Troubleshooting

The screenshot displays the 'StoreView' software interface with the following sections:

- Alarms:** A table with columns for Unit, Device Name, Address, Alarm Type, and Occurred.
- Refrigeration:** A table listing units such as Condenser A, -2DF SUCT AA, and various A1AA-1D RIFF units with their respective status, values, and setpoints.
- HVAC:** A table listing RTU units (RTU1-4) and their status, values, and alarm types.
- Lighting:** A table listing Oil Pump and Relay units with their status and alarm information.
- MISC:** A table listing various system components like Rail Heat, EMS BYPASS, and OIL PI.



AX279128111283en-000101

Online Check



1. From Network Nodes screen go to 'Config Status' tab
2. Each line item indicates a single module/controller
3. Verify all programmed modules are online

StoreView

ENGINEERING TOMORROW SS0835

File Dashboard Alarms System View Detail Schedules Info History Configuration

Location: Network Nodes Address:0 SS0835 TENAFly

Node Overview Points Scan Status Config Status Duplicates Files Upload Download

Updated: 04:49:09 PM

Type	Address	Status	Model
RO SI OI	1-1..	Online	
RO OI	1-2..	Online	
RO SI OI	1-3..	Online	
SI VO	1-4..	Online	
RO SI OI	2-1..	Online	
RO SI OI	2-2..	Online	
SI	2-3..	Online	
RO SI	3-1..	Online	
RO	4-1..	Online	
RO SI	11-1..	Online	
RO SI	12-1..	Online	
RO SI	13-1..	Online	
RO SI	14-1..	Online	
RO SI	15-1..	Online	
RO OI	99-1..	Online	
RO	99-2..	Online	
SI	36:..	Online	AK-CC550-B-012B
SI	44:..	Online	AK-CC550-B-018B
GN	1	Online	AK-CC550-B-018B
GN	2	Online	AK-CC550-B-018B
GN	3	Online	AK-CC550-B-018B
GN	4	Online	AK-CC550-B-018B
GN	5	Online	AK-CC550-B-018B
GN	6	Online	AK-CC550-B-018B
GN	7	Online	AK-CC550-B-018B
GN	8	Online	AK-CC550-B-018B



IO Communication Issues

Initial Checks

- Power
- Does module exist?
- Comm module rotary switch
- Proper comm module type?

AK-SM 800 Checks

- Proper channel enabled?

Wiring Issues

- Does polarity matter?
- EOL resistors
- Daisy-chaining and 800 termination
- Type of wire used

Problem Correction

- Rescan

Power



1. 24Vac/dc required for comm module*
2. Solid green indicator at top if power ok
3. Individual Power LED on each module as well
4. Comm module requires connection to 2nd module to power

**Will power at lower voltages (i.e. 12V), but will not bring connected modules online*



Addressing



- **AK2 Module Format Uses 3 Numbers**
- **Alternative Formats**
 - **Calculated- 'Ca-XX' format**
 - **Case Controllers-1 Number**
 - **Legacy IO (AKCess)-2 Numbers**

Setting -- Address

Input New Value

Address Type

Calculated

AK-CM

Controller

AKCess

Address

Node	Mod	Point
1	1	1

OK Cancel

Does Module Exist?

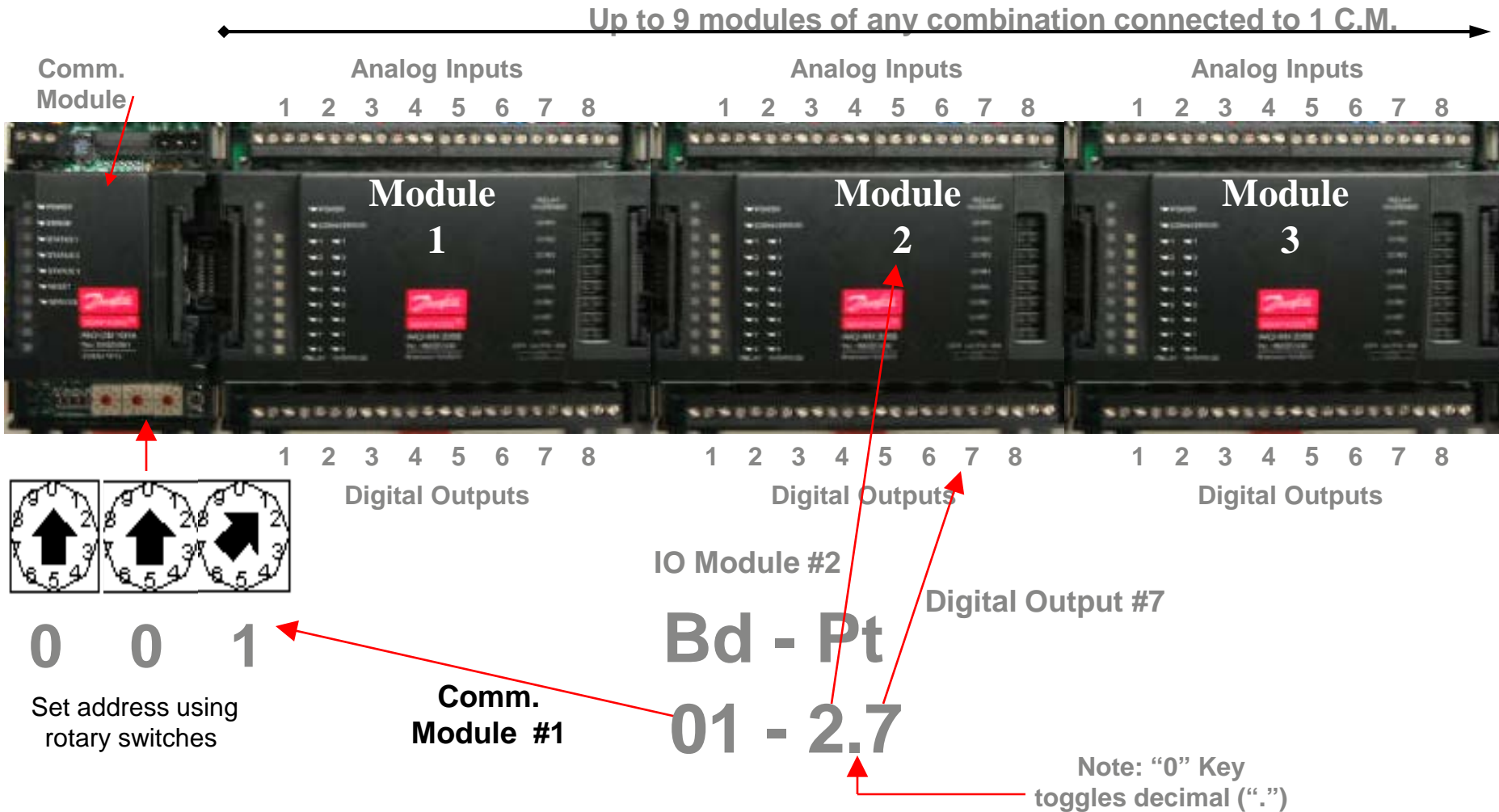

Comm Module Rotary Switch



- 3 Rotary Dials determine address
- First dial should always be set to 0
- Remaining dials determine address for 800
- To adjust dials after system is powered:
 1. Adjust dials to desired #'s
 2. Rescan system

**Addresses cannot be duplicated*

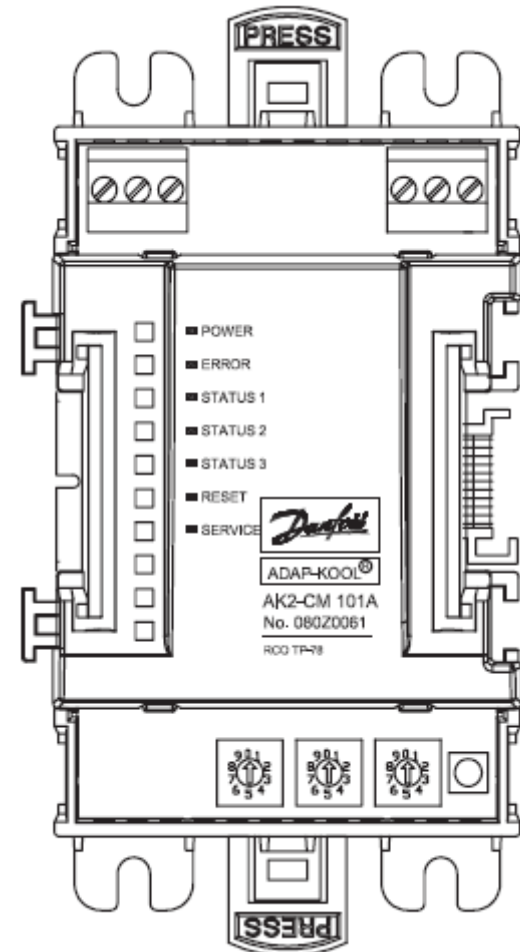

Comm Module Type



Controller	Native Comm Module Type	Part #
AK-SM 850	AK-CM 101C	080Z0063
AK-SM 880	AK-CM 101C	080Z0063
AK-SM 880R	AK-CM 101A	080Z0061



Wiring-Polarity



1. LON wiring is not polarity sensitive (TP78 or RS485)
2. Modbus wiring is polarity sensitive
3. Ensure wire not incorrectly landed on shield terminal

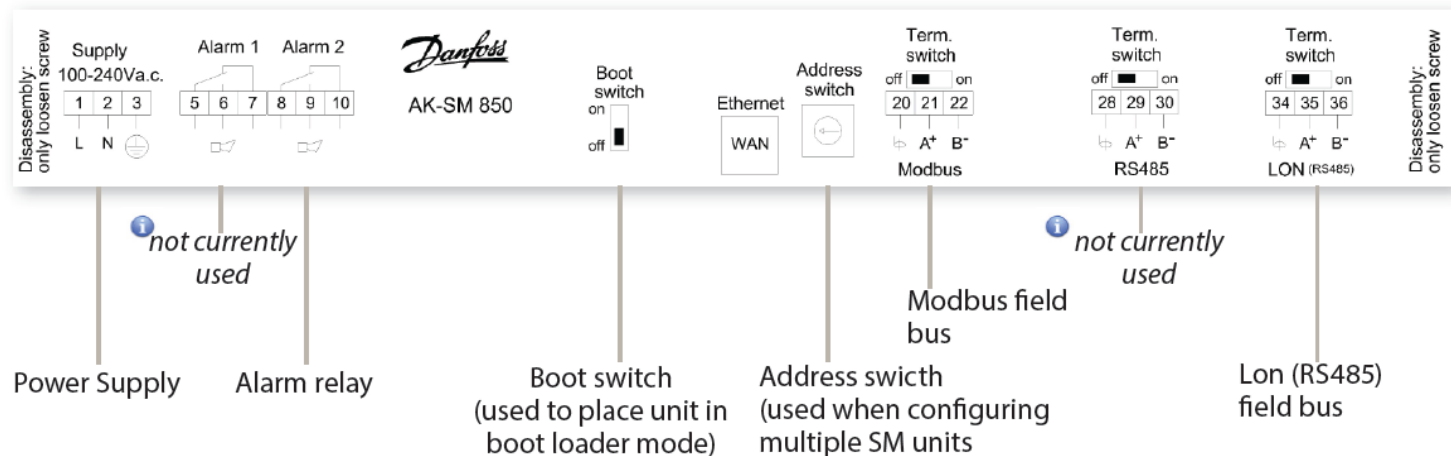
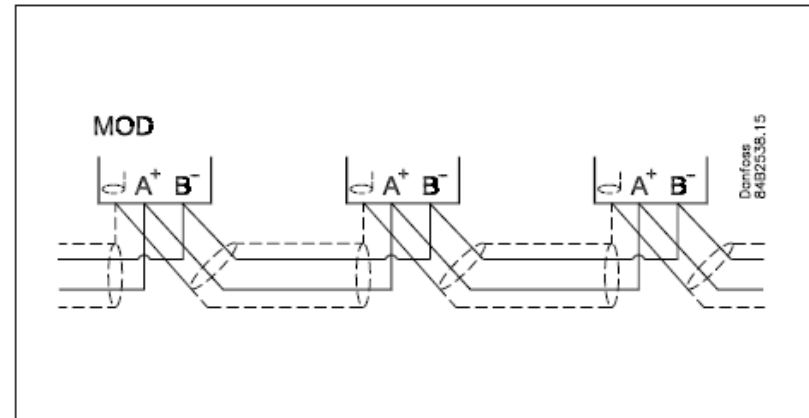
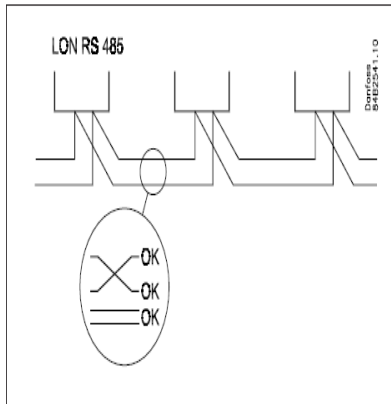

Term Switches and EOL Resistors



1. AK-SM at end of loop Term Switch = On

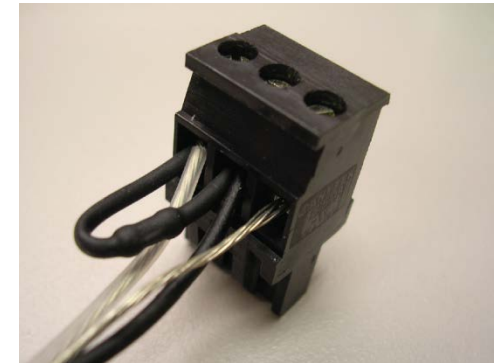
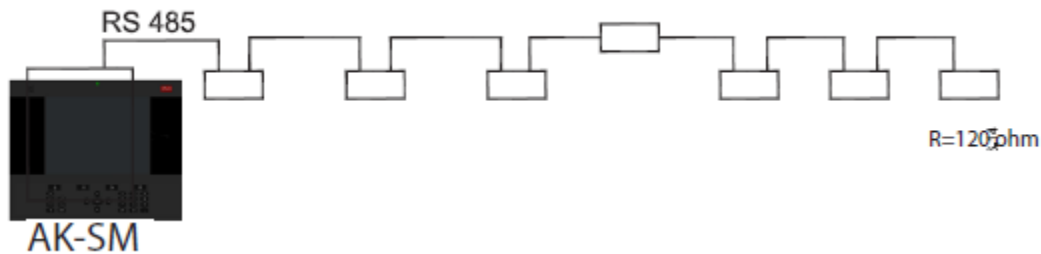

1. AK-SM in middle of loop Term Switch = Off



***Resistors now ship loose in bag**

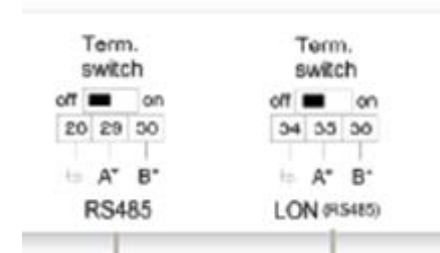

Final Checks/Problem Correction



Final Checks

- If nothing found with other checks, replacing offline module(s) is final step
- If full row of modules is offline, comm module should be changed as well
- Replace modules one at a time in case one module is affecting others

Problem Correction

- Once problem has been identified and corrected, complete rescan