

Media temperature controller

EKC 361



The controller and valve can be used where there are stringent requirements to accurate temperature control in connection with refrigeration.

E.g.:

- Cold room for fruits and food products
- Refrigerating systems
- Work premises in the food industry
- Process cooling of liquids

Features

- The temperature is kept within an accuracy of $\pm 0.25^{\circ}\text{C}$ or better after a transient phenomenon.
- The evaporator's temperature is kept as high as possible, so that the air humidity is kept high and waste is limited.
- A transient phenomenon can be controlled with the adaptive function. Select either:
 - Fast build-up where underswings are allowed
 - Not quite so fast build-up where underswings are less pronounced
 - Build-up without underswings
- PID regulation
- p_0 limitation

Introduction

Functions

- Modulating temperature control
- Digital ON/OFF input for start/stop of regulation ICS/PM or forced closing of ICM
- Alarm if the set alarm limits are exceeded
- Relay output for fan
- Relay output for solenoid valves
- Analog input signal that can displace the temperature reference as running display value. Please observe : Not possible if ICM is selected as valve
- Analog Output signal corresponding to selecting temperature as running display value. Please observe : Not possible if ICM is selected as valve

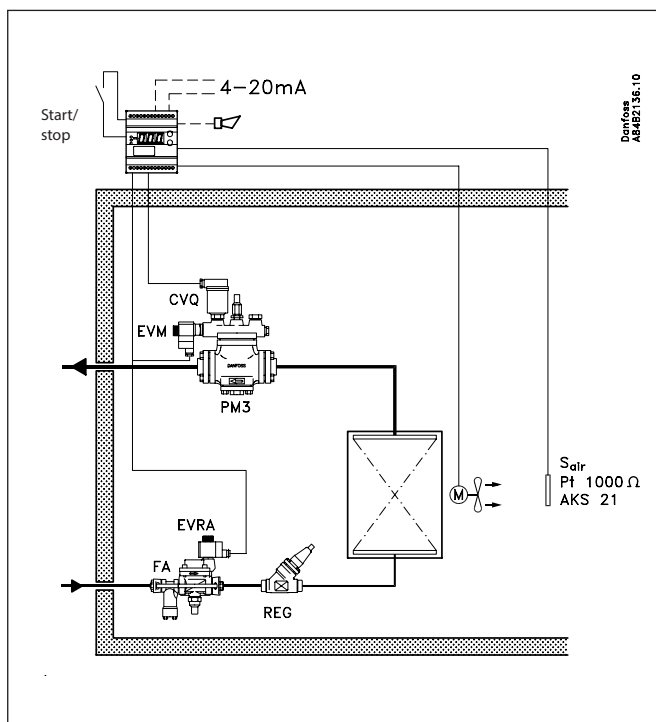
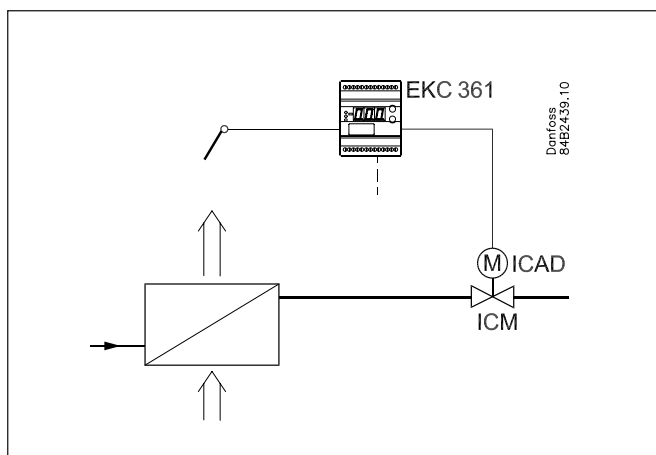
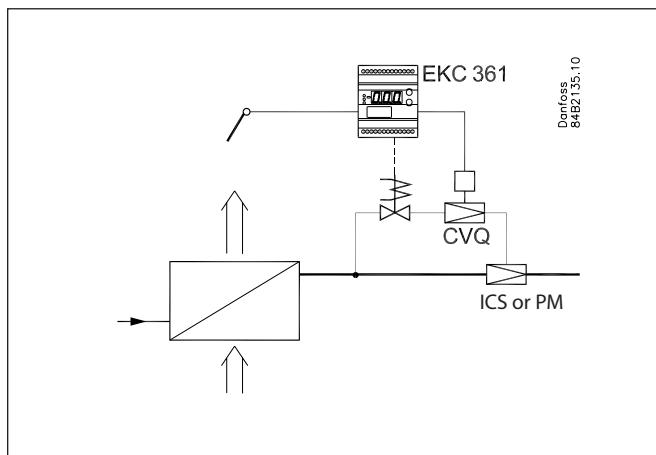

Application examples

ICS/PM

ICS/PM with CVQ is a pilot-operated and pressure-dependent valve for controlling media temperature.

The ICS or PM must be equipped with a CVQ pilot valve in order to position ICS or PM. The CVQ valve is operated by the EKC 361 controller.

Please notice that a power failure will cause the CVQ pilot valve to fully open ICS/PM. If it is required that ICS/PM must close at power failure, the pilot valve type EVM-NC can be installed.

If the Digital Input is ON, it releases the ICS/PM for controlling temperature. If the Digital Input is OFF, it stops controlling PM/ICS, but EKC 361 will maintain a CVQ minimum temperature. (Parameter n02)

Please see separate literature for ICS/PM

ICS : DKRCI.PD.HS0.A-

PM : DKRCI.PD.HL0.A-

ICM

ICM is a direct activating and pressure independent valve for controlling media temperature.

When ICM is selected, the ICM is positioned directly via the analog output 0/4-20mA output from the EKC 361.

If the Digital Input is ON, it releases the ICM for controlling temperature. If the Digital Input is OFF, the ICM is forced to close.

The opening degree OD 0-100 % can be limited by parameter n32 and n33.

Please see separate literature for ICM

ICM : DKRCI.PD.HT0.A-

General for ICS/PM and ICM

The EKC 361 can also operate a solenoid valve in the liquid line (Digital output on terminal 9 and 10). It will follow the status of Digital Input, however if a low temperature alarm is detected (A2 alarm) the solenoid valve in the liquid line will be closed.

The EKC 361 can also operate a fan (Digital output on terminal 8 and 10). It will follow the status of Digital Input.

The Parameter (r12) must be ON in order to ensure general operation. If Parameter (r12) is OFF, EKC 361 will operate corresponding to if Digital Input is OFF

As media temperature sensor is S_{air} is used. Please observe that S_{air} can also be used to control liquid.

As option an auxiliary temperature sensor S_{aux} can be installed but only for monitoring.

S_{air}/S_{aux} can both be shown as running display value selected by parameter o17. The selected sensor (S_{air} or S_{aux}) will be sent out on the Analog Output as 0/4-20 mA.

Temperature scaling with parameter o27 and o28. Please observe by ICM the Analog Output is not available for sending temperature signals (S_{air} or S_{aux}).

It is normally recommended, on a aircooler, to install S_{air} at the evaporator air outlet side.

Extra options

• PC operation

The controller can be provided with data communication, so that it may be hooked up with other products in the ADAP-KOOL® range of refrigeration controls. Operation, monitoring and data collection can then be performed from a PC - either in situ or at a service company.

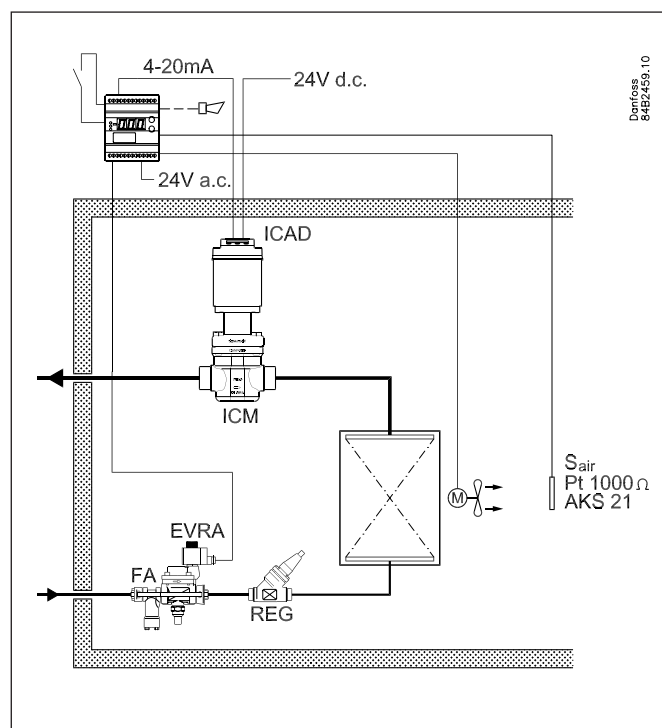
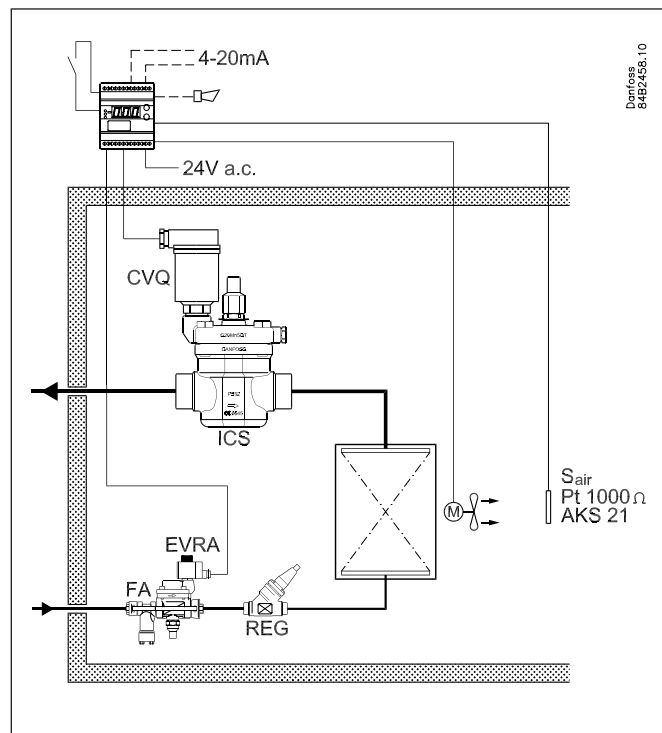

Function

Very accurate temperature control

With this system where controller, pilot valve and main valve have been adapted for optimum use in the refrigerating plant, the refrigerated products may be stored with temperature fluctuations of less than $\pm 0.25^\circ\text{C}$.

High air humidity

As the evaporating temperature is constantly adapted to the refrigeration needs and will always be as high as possible with a very small temperature fluctuation, the relative air humidity in the room will be kept at a maximum.

Drying-out of the products will in this way be reduced to a minimum.

Temperature is quickly attained

With the built-in PID control and the possibility of choosing between three transient phenomena, the controller can be adapted to a kind of temperature performance that is optimum for this particular refrigerating plant. See parameter (n07).

- **Fastest** possible cooling
- Cooling with **less** underswing
- Cooling where underswing is **unwanted**.

Regulation ICS/PM with CVQ

The controller receives signals from room sensor S_{air} . This room sensor must be placed at the air outlet from the evaporator to obtain the best possible regulation. The controller sees to it that the required room temperature is maintained. Built-in between the controller and the actuator is a so-called inner control loop which constantly checks the temperature (pressure) in the actuator's pressure vessel. In this way a very stable control system is obtained.

If there is a deviation between the required and the registered temperature the controller will immediately send more or fewer pulses to the actuator to counteract the error. A change of the number of pulses will act on the temperature and hence the pressure in the pressure vessel. As the charging pressure and the evaporating pressure p_0 follow each other, a changed charging pressure will produce the effect that the valve's opening degree is also changed. The ICS/PM with CVQ system maintains the pressure in the evaporator whatever pressure changes there may be on the suction side (on the ICS/PM valve's outlet).

Evaporating pressure limitation (p_0 limitation)

The inner control loop mentioned above also causes the evaporating pressure to stay within a fixed limit. In this way the system is safeguarded against a too low supply air temperature. It offers the following advantages:

- High-temperature systems can be connected to low-temperature compressor units
- Protection against icing on evaporator
- Frost protection of liquid coolers

Regulation with ICM

When using ICM as selected valve the system will still control ICM in order to maintain S_{air} according to entered setpoint.

This system does not include any inner control loop. It is a direct operating and pressure independent valve for controlling media temperature. (S_{air}).

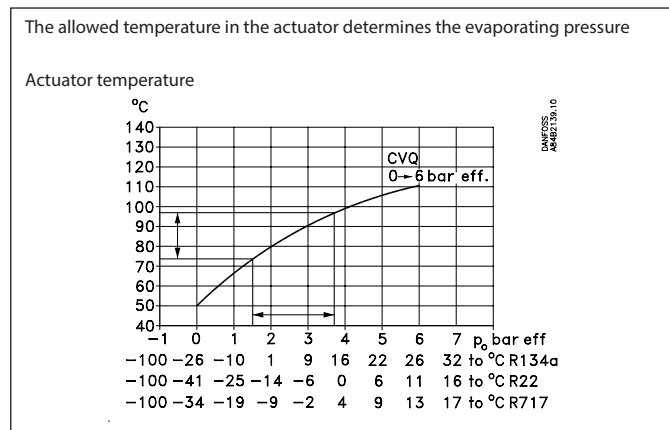
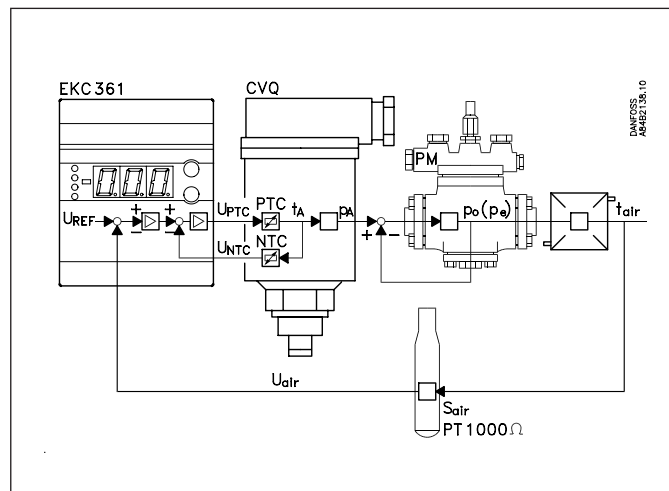
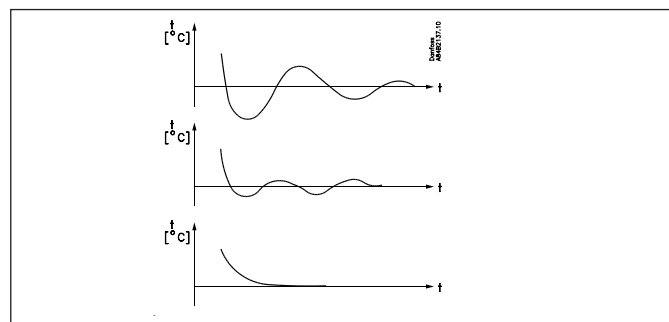
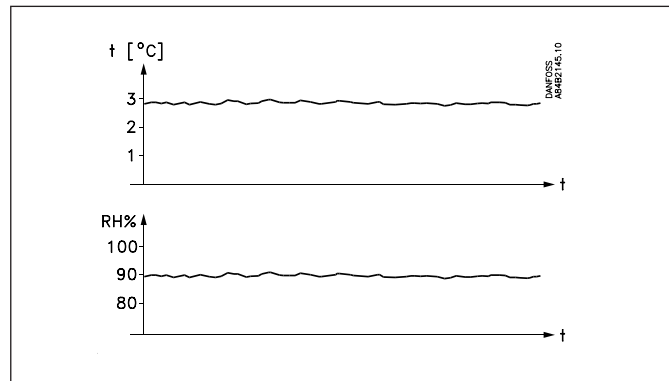

Survey of functions

Function	Parameter	Parameter by operation via data communication
Normal display		
<p>Normally S_{air} (017=Air) will be shown as running display value. If lower button is activated S_{aux} will be displayed for 5 sec, and then return to S_{air}</p> <p>If (017=Au) S_{aux} will be shown as running display value. If lower button is activated S_{air} will be displayed for 5 sec, and then return to S_{aux}</p> <p>If ICM has been selected (n03=6)</p> <p>If (017=Air) S_{air} (017=Air) will be shown as running display value. If lower button is activated OD (u24) will be displayed for 5 sec, and then return to S_{air}.</p> <p>If (017=Au) OD (u24) will be shown as running display value. If lower button is activated S_{air} will be displayed for 5 sec, and then return to OD (u24)</p>		Air temp.
Reference		
<p>Setpoint Regulation is performed based on the set value provided that there is no external contribution (o10). (Push both buttons simultaneously to set the setpoint).</p>	-	SP Temp.
<p>Temperature unit Here you select whether the controller is to indicate the temperature values in °C or in °F. If indication in °F is selected, other temperature settings will also change over to Fahrenheit, either as absolute values or as delta values.</p>	r05	Temp unit °C=0, °F=1 (In AKM only °C is displayed whatever the setting)
<p>External contribution to the setpoint This setting determines how large a contribution (in °C/°F) is to be added to the set setpoint when the input signal is max. (20 mA).</p>	r06	Ext. Ref.off set (°C/°F)
<p>Correction of signal from S_{air} (Compensation possibility through long sensor cable).</p>	r09	Adjust S_{air} (°C/°F)
<p>Correction of signal from S_{aux} (Compensation possibility through long sensor cable).</p>	r10	Adjust S_{aux} (°C/°F)
<p>Start/stop of refrigeration With this setting refrigeration can be started and stopped. Start/stop of refrigeration can also be accomplished with the external switch function. See also appendix 1.</p>	r12	Main Switch
Alarm		
The controller can give alarm in different situations. When there is an alarm all the light-emitting diodes (LED) will flash on the controller front panel, and the alarm relay will cut in.		
<p>Alarm for upper deviation The alarm for too high S_{air} temperature is set here. The value is set in Kelvin. The alarm becomes active when the S_{air} temperature exceeds the actual reference plus A01. (The actual reference (SP + r06) can be seen in u02).</p>	A01	Upper deviation
<p>Alarm for lower deviation The alarm for too low S_{air} temperature is set here. The value is set in Kelvin. The alarm becomes active when the S_{air} temperature drops below the actual reference minus A02. If a low temperature alarm is detected (A2 alarm) the solenoid valve in the liquid line (Digital output on terminal 9 and 10) will be closed</p>	A02	Lower deviation
<p>Alarm delay If one of the two limit values is exceeded, a timer function will commence. The alarm will not become active until the set time delay has been passed. The time delay is set in minutes.</p>	A03	Temp alarm delay
		With data communication the importance of the individual alarms can be defined. Setting is carried out in the "Alarm destinations" menu. See also page 10.
Control parameters		
<p>Actuator's max. temperature Set the temperature (°C) the actuator is to have at the limit of the regulating range. The setting ensures that the actuator will not become superheated and work itself away from the regulating range. Due to tolerances in the actuator the value must be set 10K higher than indicated in the curves on page 11.</p>	n01	Q-max. temp.
<p>Actuator's min. temperature Set the temperature (°C) the actuator will have at the limit of the regulating range. The setting ensures that the actuator will not become too cold and work itself away from the regulating range. Due to tolerances in the actuator the value must be set 10K lower than indicated in the curves on page 11.</p>	n02	Q-min. temp.

Actuator type Here you define the actuator mounted in the system: 1: CVQ -1-5 bar 2: CVQ 0-6 bar 3: CVQ 1.7-8 bar 4: CVMQ 5: KVQ 6: ICM	n03	Valve type
P: Amplification factor Kp If the Kp value is reduced the regulation becomes slower.	n04	Kp factor
I: Integration time Tn The I-setting can be cancelled by setting the value to max. (600s). If it is set to 600s, parameter n07 must be set to "0". (If the Tn value is increased the regulation becomes slower).	n05	Tn sec.
D: Differentiation time Td The D-setting can be cancelled by setting the value to min. (0).	n06	Td sec.
Transient phenomenon If the refrigeration requires a very fast transient phenomenon or must not have an underswing or temperature shift, this function can be used. (see page 4) 0: Ordinary regulating technique 1: Fast building-up where a minor underswing is allowed 2: Not quite so fast building-up, but without underswing	n07	Q-ctrl. mode
OD - Opening degree Max. Limitation - ICM only When ICM has been selected (n03=6) the Maximum OD can be entered. ICM will never go above this value. (If n32=n33, ICM is forced to this value)	n32	ICM OD Max.
OD - Opening degree Min. Limitation - ICM only When ICM has been selected (n03=6) the Minimum OD can be entered. ICM will never go below this value. (If n32=n33, ICM is forced to this value)	n33	ICM OD Min.
Miscellaneous		
Output signal The controller can transmit a current signal via the analog output (terminal 2 and 5). Range of current signal can be selected below: If (017=Air) Sair will send out to the analog output. If (017=Au) Saux will send out to the analog output S_{air}/S_{aux} min. value (0 or 4 mA) will correspond to the setting in "o27" S_{air}/S_{aux} max. value (20 mA) will correspond to the setting in "o28" If ICM has been selected (n03=6) OD (u24) to control ICM, is send out to the analog output (o27) and (o28) is not active Range for current signal: 0: No output signal 1: 4-20 mA 2: 0-20 mA	o09	AO type
Input signal If you wish to connect a signal that is to displace the controller's control reference, the signal must be defined in this menu. 0: No signal 1: 4-20 mA 2: 0-20 mA (4 or 0 mA will not give a displacement. 20 mA will displace the reference by the value set in menu r06).	o10	AI type
Data communication If the controller is built into a network with data communication, it must have an address, and the master gateway of the data communication must then know this address. These settings can only be made when a data communication module has been mounted in the controller and the installation of the data communication cable has been completed. This installation is mentioned in a separate document "RC8AC". The address is set between 1 and 60		Following installation of a data communication module, the controller can be operated on a par with the other controllers in ADAP-KOOL® refrigeration controls.
The address is sent to the gateway when the menu is set in pos. ON (The setting will automatically change back to Off after a few seconds.)	o03	-
	o04	-
Language This setting is only required if data communication is connected to the controller. Settings: 0=English, 1=German, 2=French, 3=Danish, 4=Spanish and 6=Swedish When the controller is operated via data communication, the texts in the right-hand column will be shown in the selected language. When you change the setting to an other language you must activate o04 before "the new language" can be visible from the AKM program.	o11	Language
Frequency Set the net frequency.	o12	50 / 60 Hz (50=0, 60=1)

<p>Selection of running display value If S_{air} (017=Air) will be shown as running display value. If lower button is activated S_{aux} will be displayed for 5 sec, and then return to S_{air}. S_{aux} will send out to the analog output. See also (o09),(o27),(o28)</p> <p>If (017=Au) S_{aux} will be shown as running display value. If lower button is activated S_{air} will be displayed for 5 sec, and then return to S_{aux}. S_{aux} will send out to the analog output. See also (o09),(o27),(o28)</p> <p>If ICM has been selected (n03=6) If (017=Air) S_{air} (017=Air) will be shown as running display value. If lower button is activated OD (u24) will be displayed for 5 sec, and then return to S_{air}</p> <p>If (017=Au) OD (u24) will be shown as running display value. If lower button is activated S_{air} will be displayed for 5 sec, and then return to OD (u24)</p>	o17	Display Aux/Air Aux =0 Air = 1
<p>(Setting for the function o09) Set the temperature value where the output signal must be minimum (0 or 4 mA)</p>	o27	Temp. at AO min.
<p>(Setting for the function o09) Set the temperature value where the output signal must be maximum (20 mA). (With a temperature range of 50°C (differential between the settings in o27 and o28) the dissolution will be better than 0.1 °C. With 100°C the dissolution will be better than 0.2°C.)</p>	o28	Temp. at AO max.
<p>Service</p>		
<p>A number of controller values can be printed for use in a service situation</p>		
<p>Read the temperature at the S_{air} sensor (calibrated value)</p>	u01	Air temp.
<p>Read the control reference (Setpoint + any contribution from external signal)</p>	u02	Air reference
<p>Read temperature at the S_{aux} sensor (calibrated value) (This showing can also be uploaded from the normal display, if you push the lowermost button for almost a second)</p>	u03	Aux. temp.
<p>Read valve's actuator temperature</p>	u04	Actuator temp.
<p>Read reference for valve's actuator temperature</p>	u05	Actuator Ref.
<p>Read value of external current signal</p>	u06	AI mA
<p>Read value of transmitted current signal</p>	u08	AO mA
<p>Read status of input DI (start/stop input)</p>	u10	DI
<p>ICM opening degree. Only active if (n03)=6</p>	u24	OD%
	--	DO1 Alarm Read status of alarm relay
	--	DO2 Cooling Read status of relay for solenoid valve
	--	DO3 Fan Read status of relay for fan
<p>Operating status</p>		
<p>Operating status of the controller can be called forth in the display. Push briefly (1s) the upper button. If there is a status code, it will be shown on the display. (Status codes have lower priority than alarm codes. In other words, you cannot see a status code, if there is an active alarm). The individual status codes have the following meanings:</p>		EKC State (0 = regulation)
<p>S10: Refrigeration stopped by the internal or external start/ stop</p>		10
<p>S12: Refrigeration stopped due to low S_{air}</p>		12

Operation

Display

The values will be shown with three digits, and with a setting you can determine whether the temperature is to be shown in °C or in °F.

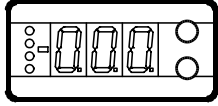

Light-emitting diodes (LED) on front panel

There are LED's on the front panel which will light up when the corresponding relay is activated.

The three lowest LED's will flash, if there is an error in the regulation.

In this situation you can upload the error code on the display and cancel the alarm by giving the uppermost button a brief push.

The controller can give the following messages:		
E1	Error message	Errors in the controller
E7		Cut-out S _{air}
E8		Short circuited S _{air}
E11		Valve's actuator temperature outside its range
E12		Analog input signal is outside the range
A1	Alarm message	High-temperature alarm
A2		Low-temperature alarm

The buttons

When you want to change a setting, the two buttons will give you a higher or lower value depending on the button you are pushing. But before you change the value, you must have access to the menu. You obtain this by pushing the upper button for a couple of seconds - you will then enter the column with parameter codes. Find the parameter code you want to change and push the two buttons simultaneously. When you have changed the value, save the new value by once more pushing the two buttons simultaneously.



- Gives access to the menu (or cutout an alarm)
- Gives access to changes
- Saves a change

Examples of operations

Set set-point

1. Push the two buttons simultaneously
2. Push one of the buttons and select the new value
3. Push both buttons again to conclude the setting

Set one of the other menus

1. Push the upper button until a parameter is shown
2. Push one of the buttons and find the parameter you want to change
3. Push both buttons simultaneously until the parameter value is shown
4. Push one of the buttons and select the new value
5. Push both buttons again to conclude the setting

Menu survey

SW =1.5x

Function	Parameter	Min.	Max.	Fac. setting
Normal display				
Shows the temperature at the selected sensor At ICM valve OD also can be selected	-		°C	
Reference				
Set the required room temperature	-	-70°C	160°C	10°C
Temperature unit	r05	°C	°F	°C
Input signal's temperature influence	r06	-50°C	50°C	0.0
Correction of the signal from S _{air}	r09	-10,0°C	10,0°C	0.0
Correction of the signal from S _{aux}	r10	-10,0°C	10,0°C	0.0
Start/stop of refrigeration	r12	OFF/0	On/1	On/1
Alarm				
Upper deviation (above the temperature setting)	A01	0	50 K	5.0
Lower deviation (below the temperature setting)	A02	0	50 K	5.0
Alarm's time delay	A03	0	180 min	30
Regulating parameters				
Actuator max. temperature	n01	41°C	140°C	140
Actuator min. temperature	n02	40°C	139°C	40
Actuator type (1=CVQ-1 to 5 bar, 2=CVQ 0 to 6 bar, 3=CVQ 1.7 to 8 bar, 4= CVMQ, 5=KVQ, 6= ICM)	n03	1	6	2
P: Amplification factor Kp	n04	0,5	50	3
I: Integration time Tn (600 = off)	n05	60 s	600 s	240
D: Differentiation time Td (0 = off)	n06	0 s	60 s	10
Transient phenomenon 0: Ordinary control 1: Underswing minimised 2: No underswing	n07	0	2	2
OD - Opening degree - max. limit - ICM only	n32	0%	100%	100
OD - Opening degree min limit - ICM only	n33	0%	100%	0
Miscellaneous				
Controller's address (0-120)	o03*	0	990	0
ON/OFF switch (service-pin message)	o04*	-	-	
Define output signal of analog output: 0: no signal, 1: 4 - 20 mA, 2: 0 - 20 mA	o09	0	2	0
Define input signal of analog input 0: no signal, 1: 4 - 20 mA, 2: 0 - 20 mA	o10	0	2	0
Language (0=english, 1=German, 2=French, 3=Danish, 4=Spanish and 6=Swedish.)When you change the setting to an other language you must activate o04 before "the new language" can be visible from the AKM program.	o11*	0	6	0
Set supply voltage frequency	o12	50 Hz/0	60 Hz/1	0
Select of running display value	o17	Au/0	Air/1	Air/1
(Setting for the function o09) Set the temperature value where the output signal must be minimum (0 or 4 mA)	o27	-70°C	160°C	-35
(Setting for the function o09) Set the temperature value where the output signal must be maximum (20 mA)	o28	-70°C	160°C	15
Service				
Read temperature at the S _{air} sensor	u01		°C	
Read regulation reference	u02		°C	
Read temperature at the S _{aux} sensor	u03		°C	
Read valve's actuator temperature	u04		°C	
Read reference of the valve's actuator temperature	u05		°C	
Read value of external current signal	u06		mA	
Read value of transmitted current signal	u08		mA	
Read status of input DI	u10		on/off	
ICM opening degree. (only at ICM)	u24		%	

*) This setting will only be possible if a data communication module has been installed in the controller.

Factory setting

If you need to return to the factory-set values, it can be done in this way:

- Cut out the supply voltage to the controller

- Keep both buttons depressed at the same time as you reconnect the supply voltage

Data

Supply voltage	24 V a.c. +/-15% 50/60 Hz, 80 VA (the supply voltage is galvanically separated from the input and output signals)	
Power consumption	Controller	5 VA
	Actuator	75 VA
Input signal	Current signal	4-20 mA or 0-20 mA
	Digital input from external contact function	
Sensor input	2 pcs. Pt 1000 ohm	
Output signal	Current signal	4-20 mA or 0-20 mA Max. load: 200 ohm
	Relay output	
Relay output	2 pcs. SPST	AC-1: 4 A (ohmic)
Alarm relay	1 pcs. SPST	AC-15: 3 A (inductive)
Actuator	Input	Temperature signal from sensor in the actuator
	Output	Pulsating 24 V a.c. to actuator
Data communication	Possible to connect a data communication module	
Ambient temperature	During operation	-10 - 55°C
	During transport	-40 - 70°C
Enclosure	IP 20	
Weight	300 g	
Mounting	DIN rail	
Display	LED, 3 digits	
Terminals	max. 2.5 mm ² multicore	
Approvals	EU Low Voltage Directive and EMC demands re CE-marking complied with. LVD-tested acc. to EN 60730-1 and EN 60730-2-9 EMC-tested acc. to EN50081-1 and EN 50082-2	

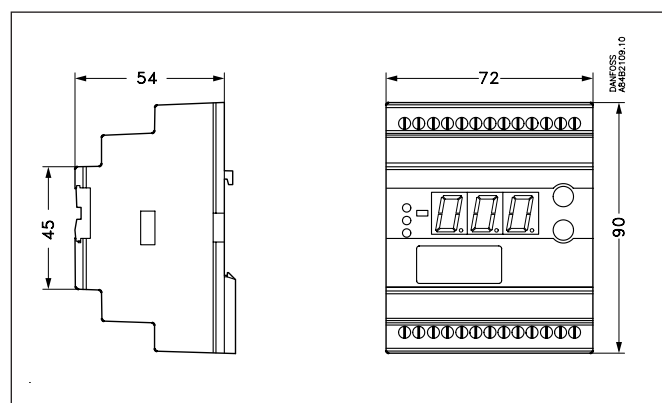

Capacitive load

The relays cannot be used for the direct connection of capacitive loads such as LEDs and on/off control of EC motors.

All loads with a switch mode power supply must be connected with a suitable contactor or similar.

Ordering

Type	Function	Code No.
EKC 361	Evaporating pressure controller	084B7060
EKA 174	Data communication module (accessories), (RS 485 module) with galvanic separation	084B7124

Temperature sensor Pt 1000 ohm:.....Kindly refer to catalogue RK0YG...
Valves:DKRCI.PD.HT0.A

Connections

Necessary connections

Terminals:

- 25-26 Supply voltage 24 V a.c.
- 17-18 Signal from actuator (from NTC)
- 23-24 Supply to actuator (to PTC)
- 20-21 Pt 1000 sensor at evaporator outlet
- 1-2 Switch function for start/stop of regulation. If a switch is not connected, terminals 1 and 2 must be short circuited.

Application dependent connections

Terminal:

- 12-13 Alarm relay
There is connection between 12 and 13 in alarm situations and when the controller is dead
- 8-10 Relay switch for start/stop of fan
- 9-10 Relay switch for start/stop of solenoid valves
- 18-19 Current signal from other regulation (Ext.Ref.)
- 21-22 Pt 1000 sensor for monitoring
- 2-5 Current output for Sair/Saux temperature or ICAD actuator for ICM valve
- 3-4 Data communication
Mount only, if a data communication module has been mounted.
It is important that the installation of the data communication cable be done correctly. Cf. separate literature No. RC8AC..

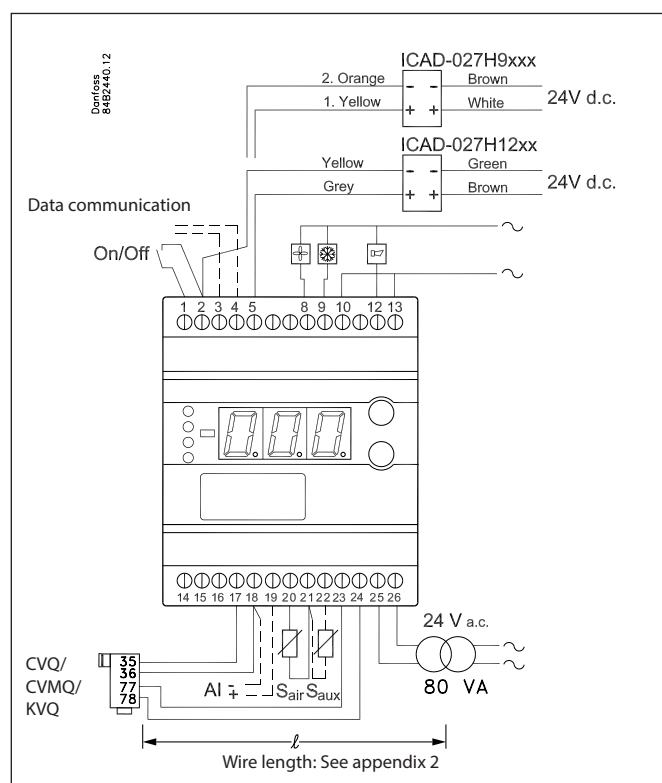

Data communication

This page contains a description of a few of the possibilities you will have when the controller is provided with data communication.

If you want to know more about operation of controllers via PC, you may order additional literature.

Examples

Each controller is provided with a plug-in module.

The controllers are then connected to a two-core cable.

The cable can be connected to a gateway type AKA 245.

This gateway will now control the communication to and from the controllers.

It will collect temperature values and it will receive alarms. When there is an alarm the alarm relay will be activated for two minutes

The gateway can now be connected to a modem.

When an alarm occurs from one of the controllers, the gateway will - via the modem - make a phone call to the service company.

At the service company a modem, gateway and PC with system software type AKM have been installed.

All the controllers' functions can now be operated from the various menu displays.

The programme will for example upload all the collected temperature values once a day.

Example of menu display

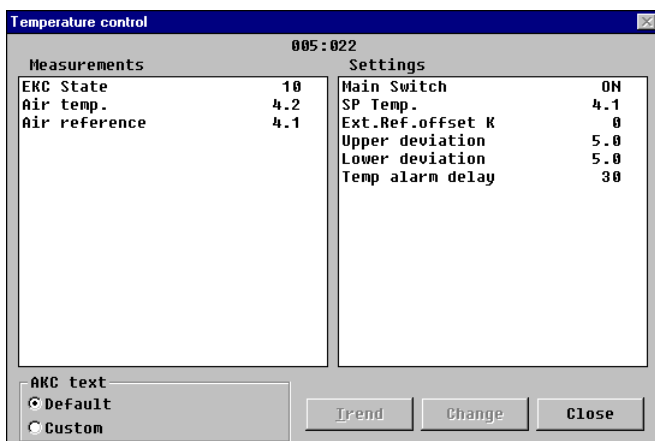

- Measurements are shown at one side and settings at the other.
- You will also be able to see the parameter names of the functions on page 5-7.
- With a simple change-over the values can also be shown in a trend diagram.
- If you wish to check earlier temperature measurements, you can see them in the log collection.

Alarms

If the controller is extended with data communication, it will be possible to define the importance of the transmitted alarms.

The importance is defined with the setting: 1, 2, 3 or 0. When the alarm then arises at some time, it will result in one of the following activities:

1 = Alarm

The alarm message is sent off with alarm status 1. This means that the gateway that is the master in the system will have its alarm relay output activated for two minutes. Later, when the alarm ceases, the alarm text will be retransmitted, but now with status value 0.

2 = Message

The alarm text is transmitted with status value 2. Later, when the "message" lapses, the alarm text is retransmitted, but now with status value 0.

3 = Alarm

As "1", but the master gateway's relay output is not activated.

0 = Suppressed information

The alarm text is stopped at the controller. It is transmitted nowhere.

Appendix 1

Interaction between internal and external start/stop functions and active functions.

Internal Start/stop	Off	Off	On	On
External Start/stop	Off	On	Off	On
Refrigeration	Off		On	
Actuator	Stand-by		Regulating	
Actuator temperature	"n02"		"n02" to "n01"	
Fan relay	Off		On	
Expansion valve relay	Off		On	
Temperature monitoring	No		Yes	
Sensor monitoring	Yes		Yes	

Appendix 2

Cable length for the CVQ actuator

The actuator must be supplied with 24 V a.c. $\pm 10\%$.

To avoid excessive voltage loss in the cable to the actuator, use a thicker cable for large distances.

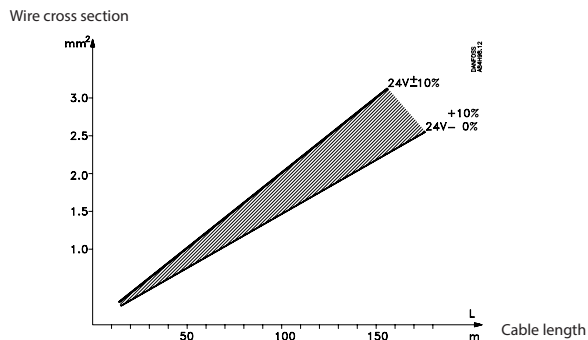

Appendix 3

Connection between the evaporating temperature and the actuator's temperature (the values are approximate).

n01: The highest regulated room temperature will have a belonging t_e value which in turn indicates the value of the n01 setting. Due to tolerances in the actuator, the setting value must be 10 K **higher** than shown in the curve.

n02: The lowest occurring suction pressure will have a belonging t_e value which in turn indicates the value of the n02 setting. Due to tolerances in the actuator, the setting value must be 10 K **lower** than shown in the curve.

CVMQ

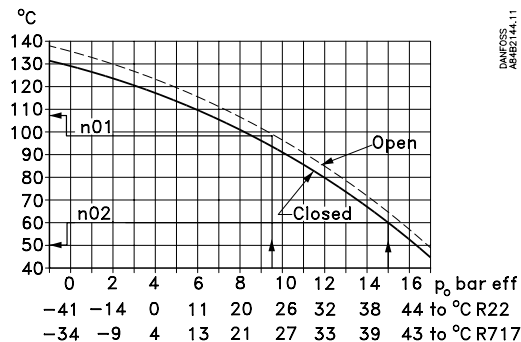

CVQ

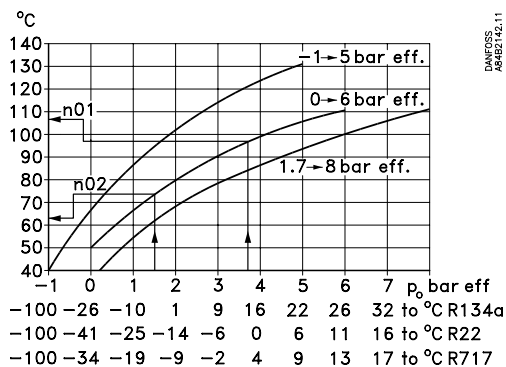

KVQ

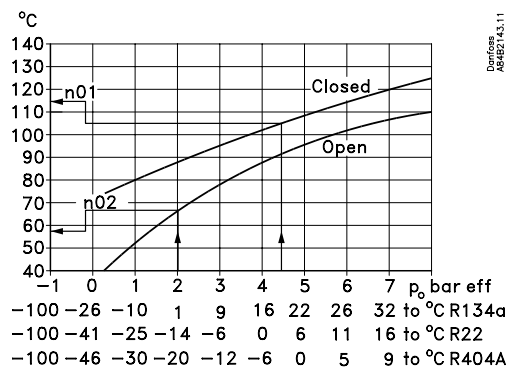

Start of controller

When the electric wires have been connected to the controller, the following points have to be attended to before the regulation starts:

1. Switch off the external ON/OFF switch that starts and stops the regulation.
2. Follow the menu survey on page 7, and set the various parameters to the required values.
3. Switch on the external ON/OFF switch, and regulation will start.

4. If the system has been fitted with a thermostatic expansion valve, it must be set to minimum stable superheating. (If a specific T0 is required for the adjustment of the expansion valve, the two setting values for the actuator temperature (n01 and n02) can be set to the belonging value while the adjustment of the expansion valve is carried out. Remember to reset the values).
5. Follow the actual room temperature on the display. (On terminals 2 and 5 a current signal can be transmitted which represents the room temperature. Connect a data collection unit, if applicable, so that the temperature performance can be followed).

If the temperature fluctuates

When the refrigerating system has been made to work steadily, the controller's factory-set control parameters should in most cases provide a stable and relatively fast regulating system.

If the system on the other hand oscillates, you must register the periods of oscillation and compare them with the set integration time T_n , and then make a couple of adjustments in the indicated parameters.

If the time of oscillation is longer than the integration time:

($T_p > T_n$, (T_n is, say, 4 minutes))

1. Increase T_n to 1.2 times T_p
2. Wait until the system is in balance again
3. If there is still oscillation, reduce K_p by, say, 20%
4. Wait until the system is in balance
5. If it continues to oscillate, repeat 3 and 4

If the time of oscillation is shorter than the integration time:

($T_p < T_n$, (T_n is, say, 4 minutes))

1. Reduce K_p by, say, 20% of the scale reading
2. Wait until the system is in balance
3. If it continues to oscillate, repeat 1 and 2

Trouble shooting - ICS/PM with CVQ

In addition to the error messages transmitted by the controller, the table below may help identifying errors and defects.

Symptom	Defect	Confirmation of defect
Media temperature too low. Actuator feels cold.	Short-circuited NTC resistor in actuator.	If less than 100 ohm is measured across terminals 17 and 18 (disassemble the lead), the NTC or the leads are short-circuited. Check the leads.
	Defective PTC resistor (heating element) in actuator.	If more than 30 ohm or 0 ohm is measured across terminal 23 and 24 (disassemble the lead), either the PTC or the leads are defective. Check the leads.
Media temperature too low. Actuator feels warm.	Undersized cable to CVQ.	Measure voltage across terminals 77 and 78 (min. 18 V a.c.). Measure resistance in power cables to CVQ (max. 2 ohm)
	Undersized 24 V transformer.	Measure voltage across transformer output terminals (24 V a.c. +10/ -15%) under all working conditions. If voltage drops under some working conditions the transformer is undersized.
	Loss of charge in actuator.	Replace actuator.
Media temperature too high. Actuator feels cold.	Fault in refrigerant plant.	Examine plant for ther defects.
Media temperature too high. Actuator feels warm.	Cut out NTC resistor in actuator.	If more than 200 kohm is measured across terminals 17 and 18 (disassemble the lead), either the NTC or leads are disconnected. Check the leads.

Fine adjustments

When the system has been operating for a while, it may be required for some systems to optimise some of the adjustments. Below we have a look at settings having an influence on the speed and accuracy of the regulation.

Adjustment of the actuator's min. and max. temperatures

At the first setting these values were set to 10 K outside of the expected temperature in order to eliminate the tolerances in the actuator. By adjusting the two values to the values where the valve is exactly in mesh, the valve will all the time remain active in its regulation.

If the actuator is replaced at a later date, this procedure must be repeated for the new actuator.

Min.

By adjusting the actuator's min. temperature you obtain a limit for how low a pressure can occur in the evaporator (the point is where the valve starts a limitation of the refrigerant flow).

The system must be put in an operating situation where max. capacity is called for (large refrigeration need).

The min. temperature must now be changed upwards step by step, at the same time as the evaporating pressure is read on the system's manometer.

When a change of the evaporating pressure is registered, this is the point where the valve is exactly in mesh. (If frost protection is required for the system, the value can be raised to the belonging value).

Max.

By adjusting the actuator's max. temperature you obtain a limit for how high a pressure can occur in the evaporator (the refrigerant flow is blocked completely).

The system is put in an operating situation where there is no call for refrigeration capacity (no refrigerant flow).

The max. temperature is now changed downwards step by step, at the same time as the evaporating pressure is read on the system's manometer.

When a change of the evaporating pressure is registered, this is the point where the valve opens. Adjust the setting a little upwards, so that the valve will again close completely for the refrigerant flow. (If the actual application has a requirement regarding max. evaporating pressure, a lower setting may of course be selected, so that the pressure is limited).

Method for fixing Kp, Tn and Td

Described below is a method (Ziegler-Nichols) for fixing Kp, Tn and Td.

1. The system is made to regulate the temperature at the required reference with a typical load. It is important that the valve regulates, and that it is not fully open.
2. Parameter u05 is read. The actuator's min. and max. setting is adjusted, so that the average of the min. and max. values is equal to the read u05.
3. The controller is set, so that it will regulate as a P-controller. (Td is set to 0, Tn in pos. OFF (600), and Q-Ctrl.mode is set at 0).
4. The stability of the system is examined by stopping the system for, say, one minute (using the start/stop setting or the switch). Now check how the building-up of the temperature proceeds. If the building-up peters out, raise Kp a little and repeat the start/stop operation. Continue with this until you obtain a building-up which does **not** peter out.
5. Kp is in this case the critical amplification ($Kp_{critical}$) and the building-up time for the continued oscillation is the critical building-up time ($T_{critical}$).
6. Based on these values, the regulating parameters can now be calculated and subsequently set:
 - If PID regulation is required:
 - $Kp < 0.6 \times Kp_{critical}$
 - $Tn > 0.5 \times T_{critical}$
 - $Td < 0.12 \times T_{critical}$
 - If PI regulation is required:
 - $Kp < 0.45 \times Kp_{critical}$
 - $Tn > 0.85 \times T_{critical}$
7. Reset the values for the controller's min. and max. temperatures and Q-Ctrl.mode.

