



Data sheet

# Pressure relief controller AFA / VFG 2(1) (PN 16, 25, 40)

Description



The controller is a self-acting pressure relief controller primarily for use in district heating systems. The controller is normally closed and opens on rising pressure.

The controller has a control valve, an actuator with one control diaphragm and a spring(s) for pressure setting.

Further on two valve versions are available:

- VFG 2 with metallic sealing cone
- VFG 21 with soft sealing cone

**Main data:**

- DN 15-250
- $k_{vs}$  4.0-400 m<sup>3</sup>/h
- PN 16, 25, 40
- Setting range:
  - 0.05-0.35 bar / 0.1-0.6 bar / 0.15-1.2 bar / 0.5-2.5 bar / 1-5 bar / 3-11 bar / 10-16 bar
- Temperature:
  - Circulation water / glycolic water up to 30 %: 2 ... 150 / 200 °C
- Connections:
  - Flange

Ordering

Example 1:  
Pressure relief controller; DN 15;  
 $k_{vs}$  4.0; metallic sealing; PN 16;  
setting range 0.15-1.2 bar;  
 $T_{max}$  150 °C; flange;

- 1x VFG 2 DN 15 valve  
Code no: .
- 1x AFA actuator  
Code no: . **1011**
- 1x Impulse tube set AF  
Code no: . .

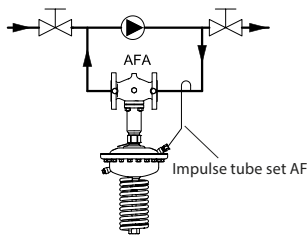

VFG 2 Valves (metallic sealing cone)

Picture	DN (mm)	$k_{vs}$ (m <sup>3</sup> /h)	$T_{max}$ (°C)	Code No.	$T_{max}$ (°C)	Code No.	
				PN 16		PN 25	PN 40
	15	4.0	150	<b>065B2388</b>	200 <sup>1)</sup>	<b>065B2401</b>	<b>065B2411</b>
	20	6.3		<b>065B2389</b>		<b>065B2402</b>	<b>065B2412</b>
	25	8.0		<b>065B2390</b>		<b>065B2403</b>	<b>065B2413</b>
	32	16		<b>065B2391</b>		<b>065B2404</b>	<b>065B2414</b>
	40	20		<b>065B2392</b>		<b>065B2405</b>	<b>065B2415</b>
	50	32		<b>065B2393</b>		<b>065B2406</b>	<b>065B2416</b>
	65	50		<b>065B2394</b>		<b>065B2407</b>	<b>065B2417</b>
	80	80		<b>065B2395</b>		<b>065B2408</b>	<b>065B2418</b>
	100	125		<b>065B2396</b>		<b>065B2409</b>	<b>065B2419</b>
	125	160		<b>065B2397</b>		<b>065B2410</b>	<b>065B2420</b>
	150	280	150	<b>065B2398</b>	150	-	<b>065B2421</b>
	200	320		<b>065B2399</b>		-	<b>065B2422</b>
	250	400		<b>065B2400</b>		-	<b>065B2423</b>
	150	280		-	200 <sup>1)</sup>	-	<b>On request</b>
	200	320		-		-	<b>On request</b>
	250	400		-		-	<b>On request</b>

<sup>1)</sup> At temperatures above 150 °C only with seal pots (see Accessories)

**Ordering (continuous)**

Example 2:  
Pressure relief controller; DN 15;  
 $k_{VS}$  4.0; metallic sealing; PN 25;  
setting range 0.15-1.2 bar;  
 $T_{max}$  200 °C; flange;

- 1x VFG 2 DN 15 valve  
Code no: **065B2401**
- 1x AFA actuator  
Code no: **003G1011**
- 1x Impulse tube set AF  
Code no: **003G1391**
- 1x Seal pot V1  
Code no: **003G1392**

Products will be delivered separately.

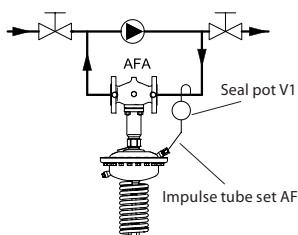

**VFG 21 Valves (soft sealing cone)**

Picture	DN (mm)	$k_{VS}$ (m <sup>2</sup> /h)	$T_{max}$ (°C)	Connections	Code No.
					PN 16
	15	4.0	150	Flanges acc, to EN 1092-1	<b>065B2502</b>
	20	6.3			<b>065B2503</b>
	25	8.0			<b>065B2504</b>
	32	16			<b>065B2505</b>
	40	20			<b>065B2506</b>
	50	32			<b>065B2507</b>
	65	50			<b>065B2508</b>
	80	80			<b>065B2509</b>
	100	125			<b>065B2510</b>
	125	160			<b>065B2511</b>
	150	280			<b>065B2512</b>
	200	320			<b>065B2513</b>
	250	400			<b>065B2514</b>

Note: other valves available on special request,

**AFA Actuators**

Picture	Pressure setting range (bar)	for DN	Code No.
	10-16	15-125	<b>003G1007</b>
	3-11		<b>003G1008</b>
	1-5		<b>003G1009</b>
	0.5-2.5		<b>003G1010</b>
	0.15-1.2	15-250	<b>003G1011</b>
	0.1-0.6		<b>003G1012</b>
	0.05-0.35		<b>003G1013</b>

**Accessories**

Picture	Type designation	Description	Connections	Code No.
	Impulse tube set AF	- 1x Copper tube Ø10 x 1 x 1500 mm - 1 x compression fitting for imp, tube connection to pipe (G 1/4) - 2 x socket	-	<b>003G1391</b>
	Seal pot V1 <sup>1)</sup>	Capacity 1 liter; with compression fittings for imp, tube Ø10	-	<b>003G1392</b>
	Seal pot V2 <sup>1)</sup>	Capacity 3 liter; with compression fittings for imp, tube Ø10, for actuator size 630 cm <sup>2</sup>	-	<b>003G1403</b>
	Compression fitting <sup>2)</sup>	For impulse tube Ø10 connections to controller	G 1/4	<b>003G1468</b>
	Shut off valve	For impulse tube Ø10	-	<b>003G1401</b>
	Throttle valve			<b>065B2909</b>

<sup>1)</sup> Seal pot has to be used on impulse tubes always when  $T_{max} \geq 150$  °C

<sup>2)</sup> Consist of a nipple, compression ring and nut

Ordering (continuous)

Service kits

Picture	Type designation	DN (mm)	k <sub>vs</sub> (m <sup>3</sup> /h)	Code No.	
				for VFG 2	for VFG 21
	Valve insert	15	4.0	065B2796	065B2790
		20	6.3	065B2797	065B2791
		25	8	065B2798	065B2792
		32	16		
		40	20	065B2799	065B2793
		50	32		
		65	50	065B2800	065B2794
		80	80		
		100	125	065B2801	065B2795
		125	160		
		150	280	065B2964	065B2966
250	400	065B2965	-		
	Stuffing cone (with EPDM O-rings)			003G1464	

Technical data

Valve

Nominal diameter	DN	15	20	25	32	40	50	65	80	100	125	150	200	250
k <sub>vs</sub> value	m <sup>3</sup> /h	4.0	6.3	8.0	16	20	32	50	80	125	160	280	320	400
Cavitation factor z		0.6	0.6	0.6	0.55	0.55	0.5	0.5	0.45	0.4	0.35	0.3	0.2	0.2
Leakage acc. to standard IEC 534 (% of k <sub>vs</sub> )	VFG 2	≤ 0.03										≤ 0.05		
	VFG 21	≤ 0.01												
Nominal pressure	PN	16, 25, 40												
Max. differential pressure	PN 16	16								15	12	10		
	PN 25, 40	20												
Media		Circulation water / glycolic water up to 30 %												
Media pH		Min. 7, max. 10												
Media temperature	VFG 2	2 ... 150 / 2 ... 200 <sup>1)</sup>										2 ... 150 (200 <sup>2)</sup> )		
	VFG 21	2 ... 150												
Connections		Flange												
<b>Materials</b>														
Valve body	PN 16	Grey cast iron EN-GJL-250 (GG-25)												
	PN 25	Ductile iron EN-GJS-400(GGG-40.3)												
	PN 40	Cast steel GP240GH (GS-C 25)												
Valve seat		Stainless steel, mat. No. 1.4021										Stainless steel, mat. No. 1.4313		
Valve cone		Stainless steel, mat. No. 1.4404										Stainless steel, mat. No. 1.4021		
Sealing	VFG 2	Metal												
	VFG 21	EPDM												
Pressure relieve system		Bellows (Stainless steel, mat. No. 1.4571)										Diaphragm (EPDM)		

<sup>1)</sup> At temperatures above 150 °C only with seal pots (see Accessories)

<sup>2)</sup> On request

Actuator

Actuator size	cm <sup>2</sup>	32			80			250			630			
Max. operating pressure	bar	25												
Pressure setting ranges and spring colours	bar	black	silver	silver	yellow	silver	yellow							
		10 – 16	3 – 11	1 – 5	0.5-2.5	0.15-1.2	0.1 – 0.6	0.05 – 0.35						
<b>Materials</b>														
Actuator housing		Steel, mat. No. 1.0338, zinc plated												
Control diaphragm		EPDM (Rolling; fibre enforced)												

Application principles

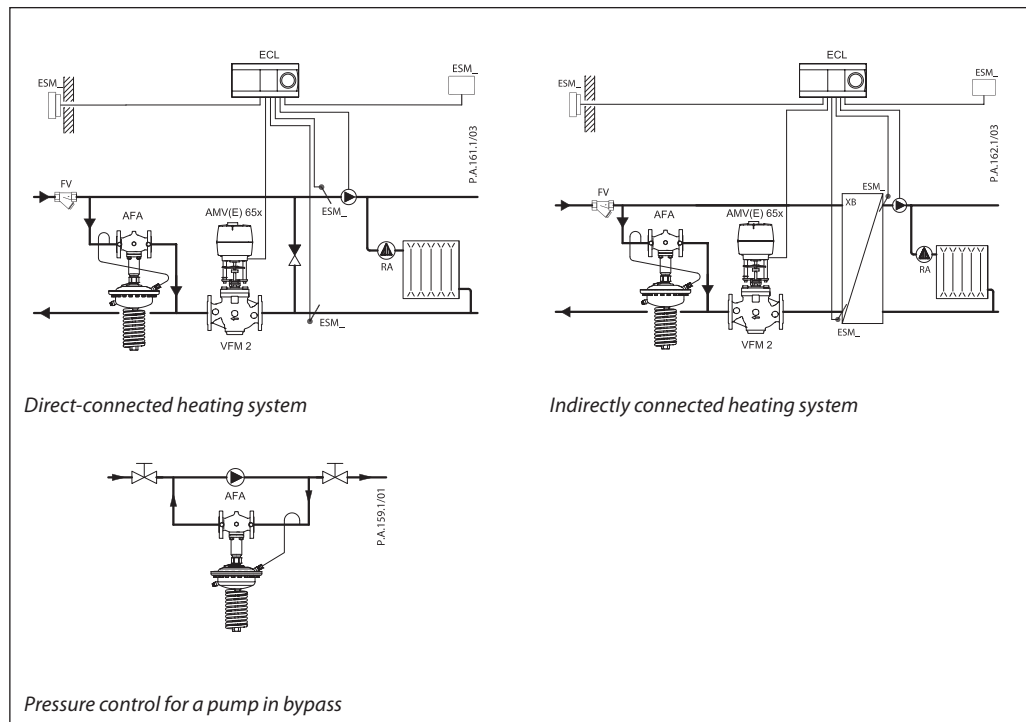

Installation position

DN 15-80  $T_{max} \leq 120\text{ }^{\circ}\text{C}$

The controllers can be installed in any position.

DN 15-80  $T_{max} > 120\text{ }^{\circ}\text{C}$ ; DN 100-250

The controllers can be installed in horizontal pipes only, with a pressure actuator oriented downwards.

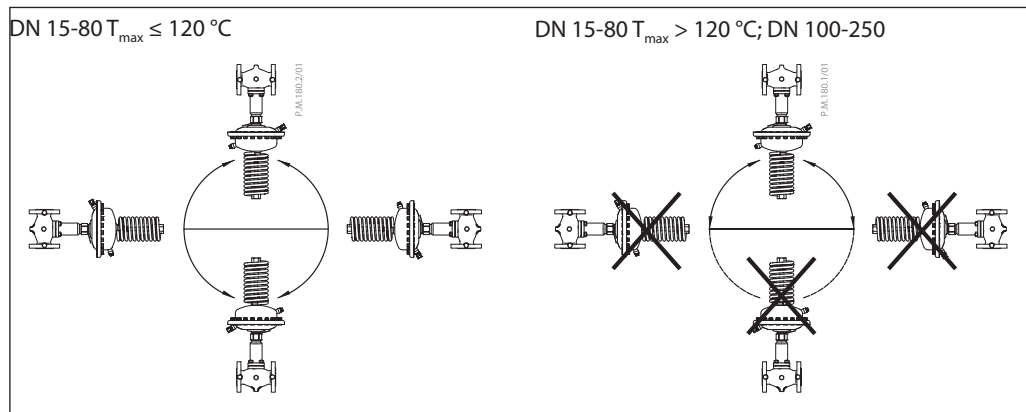

**Pressure temperature diagram**

Working area is below P-T line and it ends at Tmax for each valve

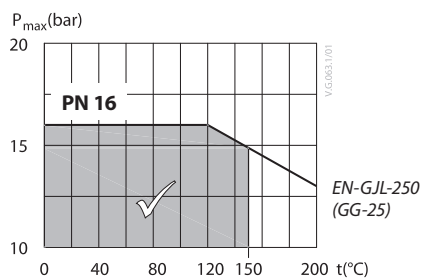

Maximum allowed operating pressure as a function of media temperature (according to EN 1092-2)

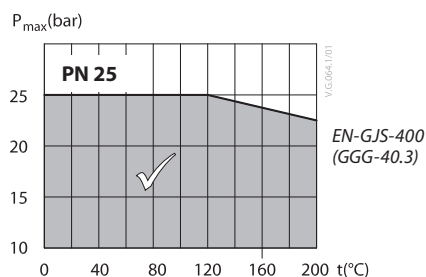

Maximum allowed operating pressure as a function of media temperature (according to EN 1092-2)

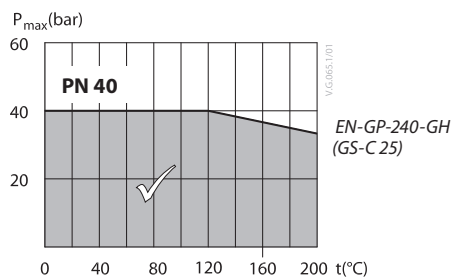

Maximum allowed operating pressure as a function of media temperature (according to EN 1092-1)

Sizing

Given data:

$$Q_{\max} = 4.0 \text{ m}^3/\text{h}$$

$$\Delta p_{\min} = 1.3 \text{ bar}$$

Nominal pressure PN 25

Solution:

The example selects AFA VFG 2 DN 15,  $k_{vS}$  value 4.0, with pressure setting range 0.5-2.5 bar.

$k_v$  value is calculated according to formula:

$$k_v = \frac{Q_{\max}}{\sqrt{\Delta p_{\min}}} = \frac{4.0}{\sqrt{1.3}}$$

$$k_v = 3.5 \text{ m}^3/\text{h}$$

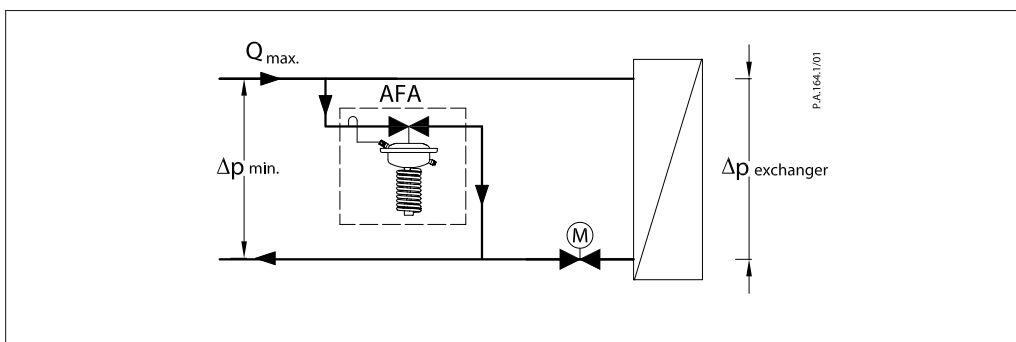
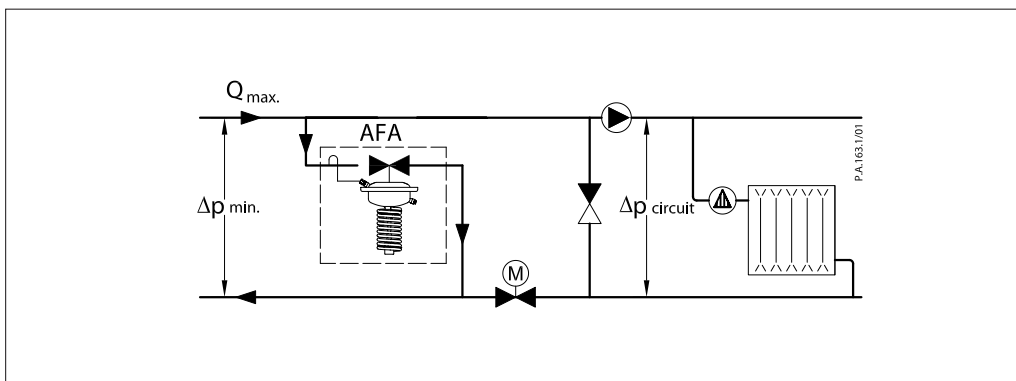

**Design**

1. Valve body
2. Cover
3. Valve seat
4. Valve insert
5. Pressure relieved valve cone
6. Valve stem
7. Bellows for pressure relief of valve cone
8. Actuator
9. Diaphragm for pressure relief of valve cone
10. Control diaphragm for pressure control
11. Setting spring for pressure control
12. Adjuster for pressure setting, prepared for sealing
13. Stuffing cone
14. Union nut
15. Compression fitting for impulse tube
16. Upper casing of diaphragm
17. Lower casing of diaphragm
18. Valve body extension
19. Shut off valve for water filling
20. Closing plug
21. Air space bore

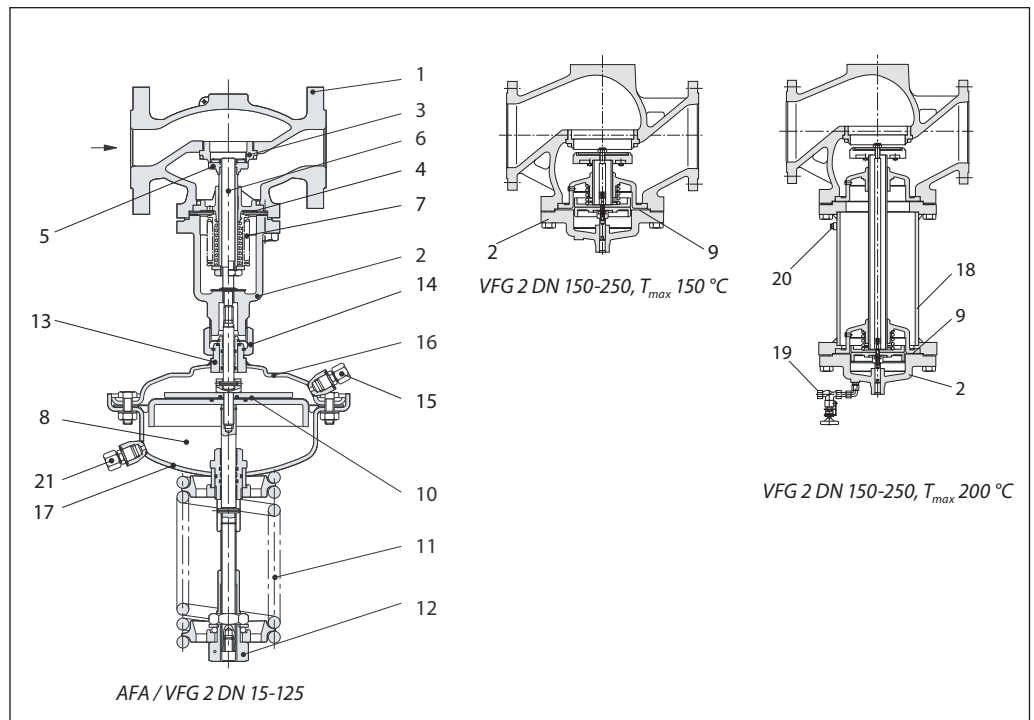

**Function**

The pressure in front of the control valve is being transferred through the impulse tube to the actuator chamber and act on control diaphragm for pressure control. On the other side of the diaphragm atmospheric pressure is acting (through air space bore). Control valve is normally closed. It opens on rising pressure and closes on falling pressure to maintain constant pressure.

**Settings**

*Pressure setting*  
 Pressure setting is being done by the adjustment of the setting spring for pressure control. The adjustment can be done by means of spring for pressure setting and pressure indicators.

Data sheet

Pressure relief controller AFA/VFG 2(1) (PN 16, 25, 40)

Dimensions

VFG DN 15-125      VFG DN 150-250      VFG DN 150-250 with valve body extension up to 200 °C

**VFG 2, VFG 21 Valves**

DN		15	20	25	32	40	50	65	80	100	125	150	200	250	
L		130	150	160	180	200	230	290	310	350	400	480	600	730	
B		213	213	239	239	241	241	276	276	381	381	326	354	401	
H		267	267	304	304	323	323	370	370	505	505	505	591	661	
Weight	PN 16 / 25	7.5	8.5	10	12	15	18	27.5	30	58	68	115	185	323	
	PN 40							30	32.5	60.5	69	141	253	333	
B <sub>i</sub>													620	852	1199
H <sub>i</sub>													799	1089	1459
Weight (valve with body extension)	PN 16 / 25												154	301	469
	PN 40												179	336	505

**AFA Actuator**

Actuator size	cm <sup>2</sup>	32	80	250	630
A	mm	172	172	263	380
H	mm	425	420	430	505
Weight	kg	7.5	7.5	13	28

Seal pot V1      Seal pot V2

Shut off valve      Compression fitting