

Installation Guide

Accessories HRB, HFE Coupling

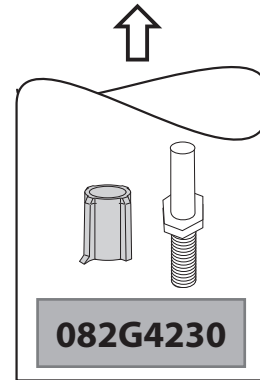
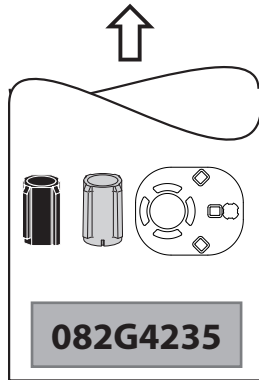

		HRB 3 065B2220 ---> 065B2230
		HRB 4 065B2240 ---> 065B2246

		HFE 3, HFE 4 065B5120 ---> 065B5250 065B6132 ---> 065B6250
		HRB 3, HRB 4 ¹⁾ 065B2177 ---> 065B2206 HRE 3, HRE 4 ¹⁾ 065B5019 ---> 065B5051 065B6019 ---> 065B6051

¹⁾ gen ---> 2008

1

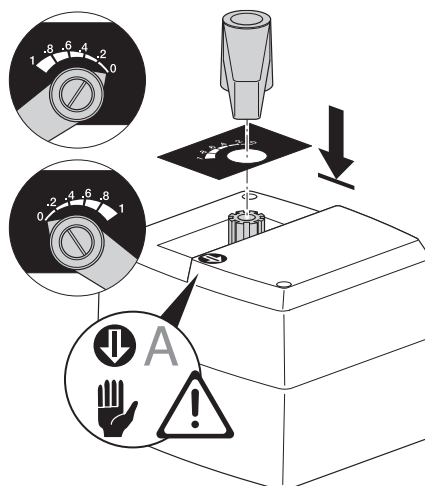

Installation Guide Accessories HRB, HFE Coupling

2

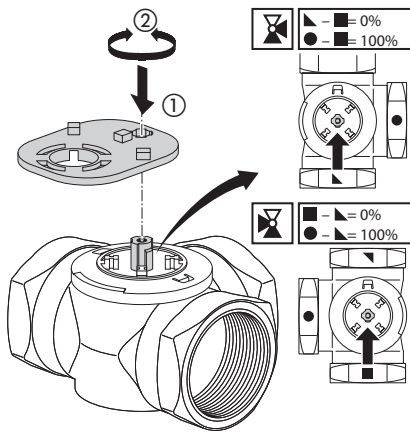

HRB 3

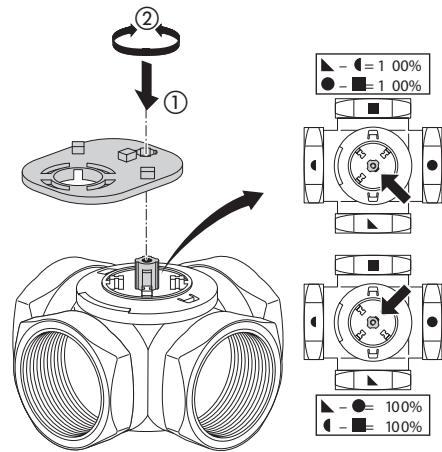

HRB 4

3

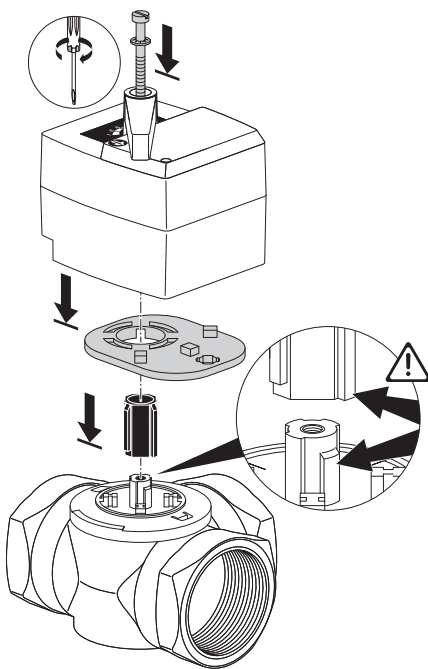

HRB 3

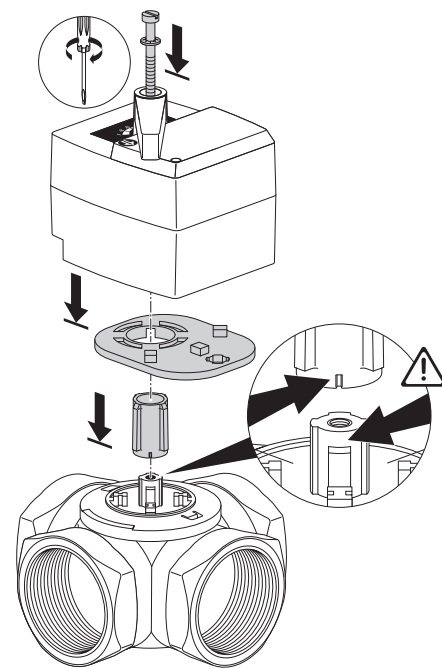

HRB 4

4

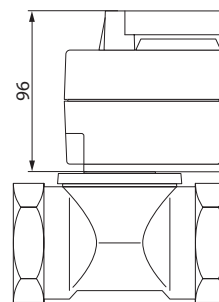
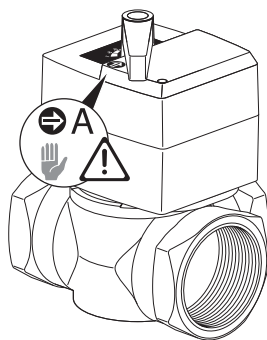

Danfoss can accept no responsibility for possible errors in catalogues, brochures and other printed material. Danfoss reserves the right to alter its products without notice. This also applies to products already on order provided that such alterations can be made without subsequential changes being necessary in specifications already agreed. All trademarks in this material are property of the respective companies. Danfoss and the Danfoss logotype are trademarks of Danfoss A/S. All rights reserved.