

Installation and User Guide



living connect[®] Electronic Radiator Thermostat

Installation Guide

1. Installation

1.1	Identify your <i>living connect</i> ® thermostat	4
1.2	In the package	4
1.3	Overview of valve adapters	5
1.4	Installing the right adapter	6
1.5	Inserting the batteries	7
1.6	Using the buttons	7
1.7	Installing <i>living connect</i> ®	8
1.8	Automatic adjustments	8
1.9	Removing <i>living connect</i> ®	9
1.10	Resetting <i>living connect</i> ® to default settings	9
1.11	Removing an adapter from <i>living connect</i> ®	10

2. Technical specifications

Pay a visit to the *living* web-site, where you find a lot of additional information: animations and videos, a FAQ section, literature and much, much more

living.danfoss.eu



Scan this QR code with your smartphone and go directly to the *living connect*® Installation video on YouTube.

User Guide

3. Overview of display and control buttons	12
4. Connecting <i>living connect</i>[®] to a Danfoss Link™ system	
4.1 Configuring rooms in Danfoss Link™ CC	12
4.2 Connecting <i>living connect</i> [®] to Danfoss Link™ CC	12
4.3 Testing the connection	14
5. Additional settings	
5.1 Adjustments for over/undersized radiators	14
5.2 Open-window function	15
5.3 Automatic valve exercising	15
6. Safety precautions	15
7. Disposal	15

1. Installation

1.1 Identify your living connect® thermostat

living connect® comes in several versions to meet the demands of different markets.

You identify your version by the code number on the box label. Adapters for a range of different valves types are available as accessories, see chapter 1.3.



Code no.	Version characteristics	Quick guide languages
014G0001	Incl. pre-mounted RA adapter	UK, DE, DK, NL, FR, PL, SE, FI
014G0002	Incl. RA + M30 x 1.5 adapters	UK, DE, DK, NL, FR, PL, SE, FI
014G0003	Incl. RA + M30 x 1.5 adapters	UK, CZ, SK, RU, TR, HU, HR, SI

1.2 In the package

living connect® 014G0001 is supplied with a pre-mounted adapter for Danfoss RA valves, two alkaline AA batteries, a 2 mm Allen key and a Quick Guide in languages English, German, Danish, Dutch, French, Polish, Swedish and Finnish.

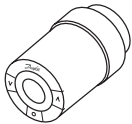

living connect® sensor



Alkaline AA batteries

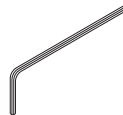

Allen key, 2 mm



Quick Guide and "Hanger"

living connect® 014G0002 and 014G0003 are supplied with adapters for Danfoss RA valves and valves with M30 x 1.5 (K) connections, two alkaline AA batteries, a 2 mm Allen key and a Quick Guide in English, German, Danish, Dutch, French, Polish, Swedish and Finnish (014G0002) or in English, Czech, Slovak, Russian, Turkish, Hungarian Croatian and Slovenian (014G0003).

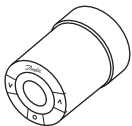

living connect® sensor



Adapter for RA valves



Adapter for M30 x 1.5 (K) valves

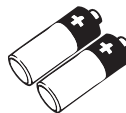

Alkaline AA batteries

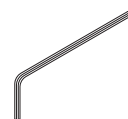

Allen key, 2 mm



Quick Guide and "Hanger"

1.3 Overview of valve adapters

Adapters for a wide range of different valve types are available as accessories.

Adapter type	Code no.	Adapter	Valve
For Danfoss RA valves	014G0251		
For M30 x 1.5 (K) valves	014G0252		
For Danfoss RAV valves	014G0250		
For Danfoss RAVL valves			
For Danfoss RTD valves	014G0253		
For M28 valves:			
- MMA	014G0255		
- Herz	014G0256		
- Orkli	014G0257		
- COMAP	014G0258		

1.4 Installing the right adapter

Adapter for RA valves (pre-mounted on 014G0001)

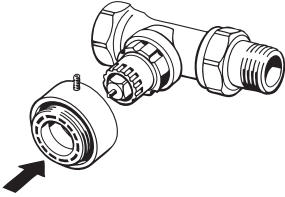
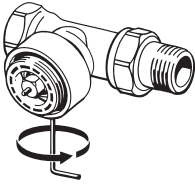
<p>1.</p>  <p>Place the RA adapter on the valve as shown.</p>	<p>2.</p>  <p>Tighten the adapter with the 2 mm Allen key.</p>
--	---

Adapter for M30 x 1.5 (K) valves

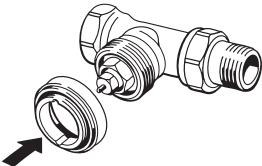
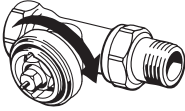
<p>1.</p>  <p>Place the K adapter on the valve as shown.</p>	<p>2.</p>  <p>Hand-tighten the K adapter (max. 5 Nm).</p>
---	--

Adapter for RAV valves (accessory)

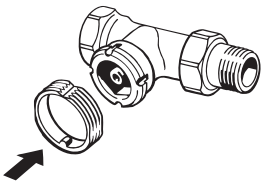
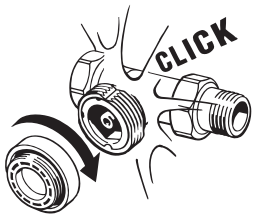
<p>1.</p>  <p>Click the inner adapter on the valve.</p>	<p>2.</p>  <p>Hand-tighten the outer adapter (max. 5 Nm).</p>
---	---

Adapter for RAVL valves (accessory)

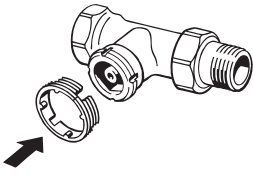
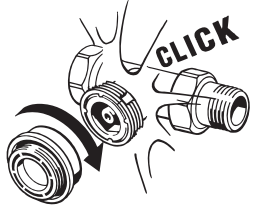
<p>1.</p>  <p>Click the inner adapter on the valve.</p>	<p>2.</p>  <p>Hand-tighten the outer adapter (max. 5 Nm).</p>
--	--

Adapter for RTD valves (accessory)

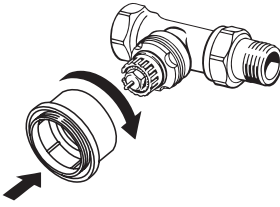
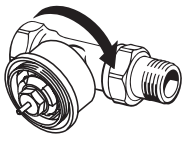
<p>1.</p>  <p>Place the RTD adapter on the valve as shown.</p>	<p>2.</p>  <p>Hand-tighten the RTD adapter (max. 5 Nm).</p>
---	--

Adapters for M28 valves (accessories)

Please follow the instructions supplied with the valve adapter for the specific M28 valve.

1.5 Inserting the batteries

Remove the battery cover and insert two AA batteries. Make sure the batteries are correctly oriented.

Rechargeable batteries **must not** be used.

When replacing batteries the programme settings will be preserved, but after two minutes the settings for time and date are reset.

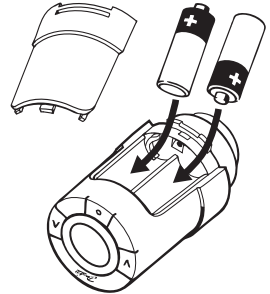



The low battery symbol  is displayed approx. one month before the batteries run out.

After approx. two weeks the  symbol will flash 14 times from 19:00 to 21:00 hrs.

Before the batteries run out *living connect®* will leave the valve in a slightly open position to protect the valve from damage.

1.6 Using the buttons

living connect® has two arrow buttons   which allow you to navigate the display and the menus and to set the temperature*.



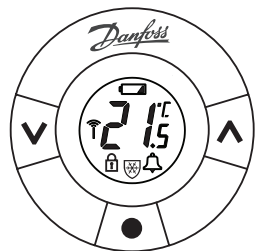

The dot button  is used to select and confirm.

If the display is off, press either button to activate the display.

**The temperature is usually controlled via Danfoss Link™ CC, but may be changed at any time using the thermostat's buttons. If this is done, the thermostat sends a message to Danfoss Link™ CC, instructing it to synchronise the other thermostats in the same room.*

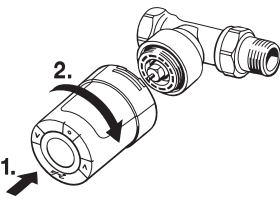
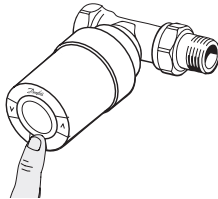

1.7 Installing living connect®

<p>1.</p>  <p><i>living connect</i>® must be in Installation Mode to be fixed correctly onto the valve. This is indicated by a large, flashing 111 in the display. Installation Mode can be selected by pressing  for 3 seconds until 111 is displayed, then release and press  again.</p>	<p>2.</p>  <p>Screw <i>living connect</i>® onto the adapter and tighten by hand (max. 5 Nm). While slightly pressing forward, turn <i>living connect</i>® clockwise until it locks, then tighten.</p>
<p>3.</p>  <p>Press  to fix <i>living connect</i>®.</p>	<p>4.</p>  <p>Icons for Network Connection and Alarm are flashing, indicating <i>living connect</i>® is ready for connection with Danfoss Link™ CC.</p>

1.8 Automatic adjustments

During the first night of operation *living connect*® will shut off the radiator heat and then open again to detect the exact opening point of the valve. This will allow *living connect*® to control the heat as efficiently as possible. If necessary, the procedure is repeated once a night for up to a week. You might experience the valve being warm during the adjustment procedure, regardless of the room temperature.

Intelligent Control (Forecast)

During the first week of operation *living connect*® learns when it is necessary to start heating the room in order to reach the correct temperature at the correct time.





The intelligent control will continuously adjust the heating time compared to seasonal temperature changes.

Using Saving Program requires that your heating system has enough heat for a short period during heat up. If your experience problems you should contact your installer.

1.9 Removing *living connect*®

1.



Activate Installation Mode: Press  for 3 seconds to select the Function Menu. Select  with . When  flashes, press .

2.

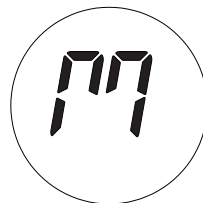

A large  is flashing in the display to indicate that Installation Mode is activated.

3.

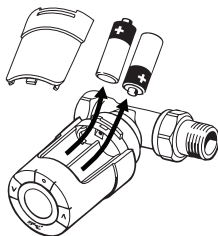

Remove the battery cover and the batteries.

4.

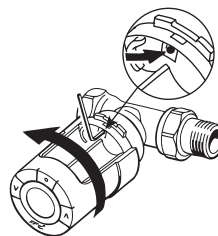

Insert the Allen key or similar into the hole to lock the adapter ring. Turn counterclockwise to unscrew *living connect*® from the adapter.

1.10 Resetting *living connect*® to default settings

1.

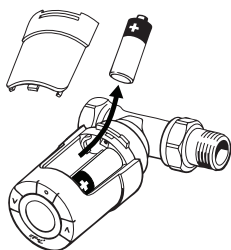

Remove the battery cover and take out one battery.

2.

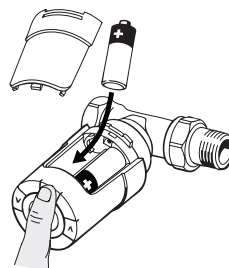

Press and hold  for approx. 5 seconds, while reinserting the battery.

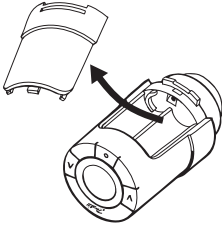
1.11 Removing an adapter from living connect®**1.**

Remove the battery cover.

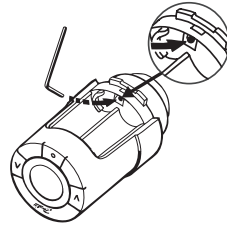
2.

Insert a small hex key or similar into the locking hole to lock the adapter ring.

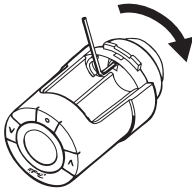

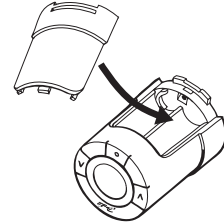

3.

With the hex key locking the adapter ring, turn the adapter in the shown direction.

4.

Put back the battery cover. Mount *living connect*® on another valve adapter according to the instructions supplied with the adapter.

2. Technical specifications

Thermostat type	Programmable electronic radiator valve controller
Recommended use	Residential (pollution degree 2)
Actuator	Electromechanical
Display	Grey digital with backlight
Software classification	A
Control	PID
Transmission frequency / range	868.42 MHz / up to 30 m
Power supply	2 x 1.5 V alkaline AA batteries
Power consumption	3 μ W in standby, 1.2 W when active
Battery life	2 years
Low battery signal	Battery icon will flash in display. If battery level is critical, the whole display will flash.
Ambient temperature range	0 to 40 °C
Transportation temperature range	-20 to 65 °C
Maximum water temperature	90 °C
Temperature setting range	4 to 28 °C
Measurement interval	Measures temperature every minute
Clock accuracy	+/- 10 min/year
Spindle movement	Linear, up to 4.5 mm, max. 2 mm on valve (1 mm/s)
Noise level	<30 dBA
Safety classification	Type 1
Open-window function	Activated at temperature decrease of approx. 0.5 °C over 3 min.
Weight (incl. batteries)	177 g (with RA adapter)
IP class	20 (not to be used in hazardous installations or in places where it will be exposed to water)
Approvals, markings etc.	   

Tested for safety and EMC requirements as specified in EN 60730-1, EN 60730-2-9 and EN 60730-2-14.

3. Overview of display and control buttons

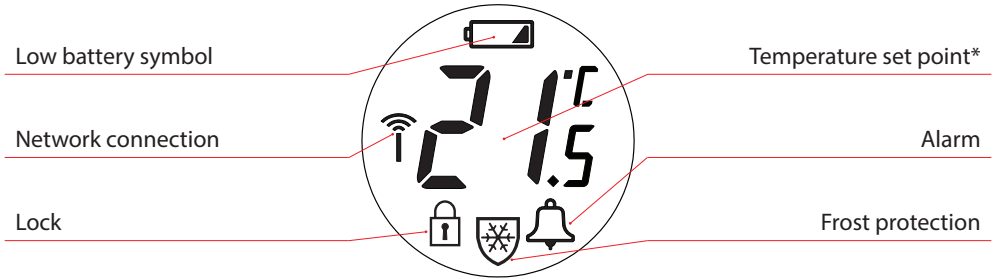

Use these buttons to navigate within the menu and to adjust the temperature.

Use this button to select the menu and confirm choices.

* *living connect* is displaying the **set temperature**, not the **measured room temperature**.

4. Connecting *living connect*® to a Danfoss Link™ system

4.1 Configuring rooms in Danfoss Link™ CC

Make sure that the room in which *living connect*® has been installed, has been configured in Danfoss Link™ CC - see installation guide for Danfoss Link™ CC.

4.2 Connecting *living connect*® to Danfoss Link™ CC

<p>1.</p> <p>max. 150 cm</p> <p>Move the Danfoss Link™ CC within a distance of 1.5 m from the thermostat (the battery pack 014G0262 is recommended).</p>	<p>2.</p> <p>The "Configure room" menu is displayed. Select "Room devices".</p>
--	---

3.

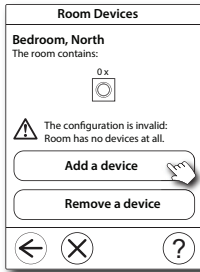

Select "Add a device".

4.

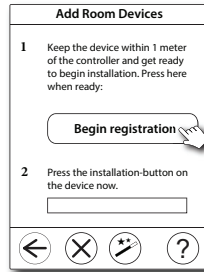

Press "Begin Registration", and then press and release  on the thermostat.

5.

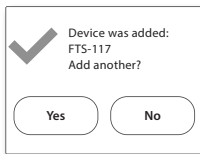

Choose "Yes" to add another device to the room, choose "No" to continue.

6.

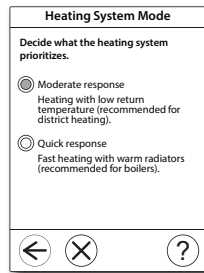

Choose Heating System and press .



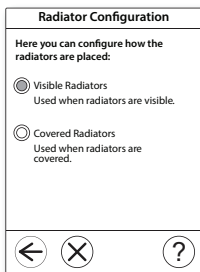



7.



Choose Radiator Type and press  (only with Danfoss Link™ RS room sensor).









8. Once a device has been registered and the Danfoss Link™ CC is placed in final position, you must perform a network test - see installation guide for Danfoss Link™ CC

4.3 Testing the connection

<p>1.</p>  <p>Press  for at least 3 seconds until m is displayed.</p>	<p>2.</p>  <p>Press  until L is displayed. Press  to make the connection. L disappears when the connection is made.</p>	<p>3.</p>  <p>If no connection can be made, the alarm and antenna symbols will both be flashing. Refer to "Technical questions" at www.living.danfoss.eu</p>
--	--	--

5. Additional settings

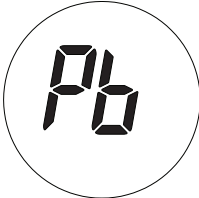
5.1 Adjusting to radiator/room conditions

<p>Press  for at least 3 seconds until m is displayed. Press  until Pb is displayed, then press .</p> <p>The default setting is P2. Use P1 if the radiator appears oversized for the room. Use P3 if it is undersized.*</p> <p>Select P1, P2 or P3 using  and  and exit using .</p> <p>* The frequency of P1, P2 and P3 regulation varies to compensate for radiator over/under sizing.</p>	 
--	---

5.2 Open-window function

living connect® features an Open-window function, which closes the valve if the room temperature is falling dramatically, thus reducing the heat loss.

The heat is turned off in the entire room for up to 30 minutes, before *living connect*® returns to its original settings.

When Open-window has been activated, the function is quarantined for 45 minutes.

Note! Be aware that the Open-window function will be affected, if curtains or furniture is covering living connect®, thus preventing it from detecting the decreasing temperature.

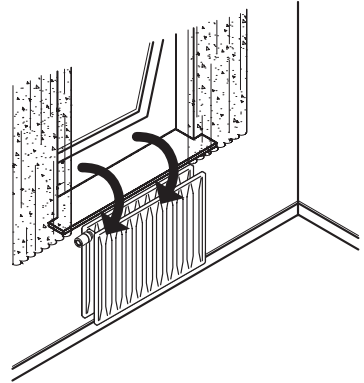

5.3 Automatic valve exercising

To keep the radiator valve functional and at its best, *living connect*® automatically exercises the valve every Thursday at approx. 11:00 hrs by opening it fully and then return to normal setting.

6. Safety precautions

The thermostat is not intended for children and must not be used as a toy.

Do not leave packaging materials where children may be tempted to play with them, as this is extremely dangerous.

Do not attempt to dismantle the thermostat as it contains no user-serviceable parts. If error code E1, E2 etc. is shown in the display or other defects appear, please return the thermostat to the distributor.

7. Disposal

The thermostat must be disposed of as electronic waste.



Installer

Danfoss A/S

Haarupvaenget 11
DK-8600 Silkeborg
Denmark

Phone: +45 7488 8000

Fax: +45 7488 8100

www.danfoss.com

www.living.danfoss.eu