

ENGINEERING  
TOMORROW

*Danfoss*

Data Sheet

## Valve station Type **ICF SS 20** and **ICF SS 25**

A complete range of modern, flexible stainless steel components  
for Industrial refrigeration

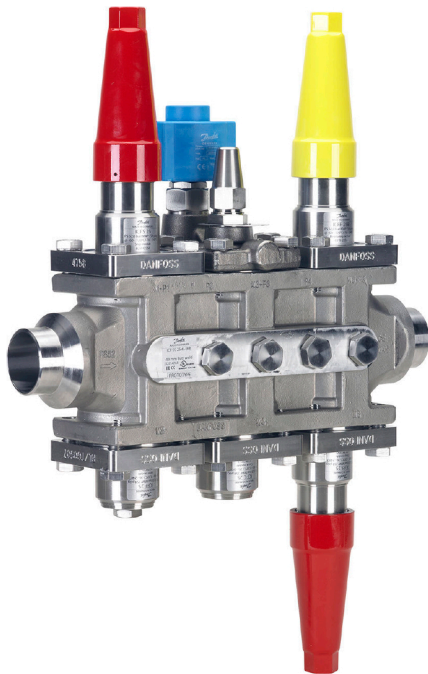

Based on advanced technology the ICF SS valve station incorporates several functions in one housing, which can replace a series of conventional mechanical, electro-mechanical and electronically operated valves.

This valve station not only provides a number of advantages in the design phase of a refrigeration plant but also in the installation, service and maintenance.

The ICF SS valve stations are designed for low and high pressure refrigerants and can be used in pumped liquid lines, liquid injection lines and hot gas lines.

Supplied as a complete assembly, it is fully tested at high pressure and its functions are tested under factory controlled conditions.

One code number equals one application solution.

**ЮГОВ - Проект**  
інженерно-виробниче підприємство

офіційний дистриб'ютор  
Danfoss в Україні



[ugov.ua](http://ugov.ua)

AI243586442520en-000901

## Features

- Designed for industrial refrigeration applications for a maximum working pressure of 52 bar / 754 psig
- Applicable to HCFC, non flammable HFC, R717 (Ammonia) and R744 (CO<sub>2</sub>). The use of ICF SS valve stations with flammable hydrocarbons is not recommended
- Direct weld connections (No leaks through flanges)
- Stainless steel valve housing and function modules
- Low weight and compact design
- V-port regulating cones on the control modules ensure optimum regulating accuracy particularly at part load
- Modular Concept
  - Each housing is available with butt-weld DIN connections in several sizes. Valve service is performed by replacing the function module
  - Side ports for the connection of pressure gauges, transmitters, sight glasses, service valve etc
- UL approved

## Applications

To facilitate selection of the right ICF SS valve station Danfoss has predefined and grouped a large number of code numbers matching common applications:

### Liquid feed

**Table 1: Liquid feed**

Application #		Sequence of functions					
1	Liquid feed (No hotgas defrost)	Stop	Filter	Solenoid	Man Open	Regul.	Stop
2	Liquid feed	Stop	Filter	Solenoid	Man Open	Regul.	Stop/Check
3	Liquid feed	Stop	Filter	Solenoid	Check	Regul.	Stop
10	Liquid feed (No hotgas defrost)	Stop	Filter	Solenoid	Regul.		
15	Liquid feed with external connection	Stop	Filter	Solenoid	Check	Welding	Regul.

### Liquid injection

**Table 2: Liquid injection**

Application #		Sequence of functions					
5	Liquid injection (expansion)	Stop	Filter	Solenoid	Man Open	Motor	Stop
14	Liquid injection (expansion)	Stop	Filter	Motor	Stop		

### Hot gas defrost

**Table 3: Hot gas defrost**

Application #		Sequence of functions					
9	Hot gas defrost	Stop	Filter	Solenoid	Solenoid		

### Miscellaneous

**Table 4: Miscellaneous**

Application #		Sequence of functions					
90	Multipurpose configurations						

**NOTE:**

For specific identification of the different codes and flow capacity ( $K_v$ ) please refer to ordering section.

### Examples of application:

#### Liquid feed line

A valve combination for a flooded evaporator operating on/off from a thermostat and with electric defrost is required. Manual override of the solenoid valve is requested. Common ICF SS configurations for this kind of application is shown here:

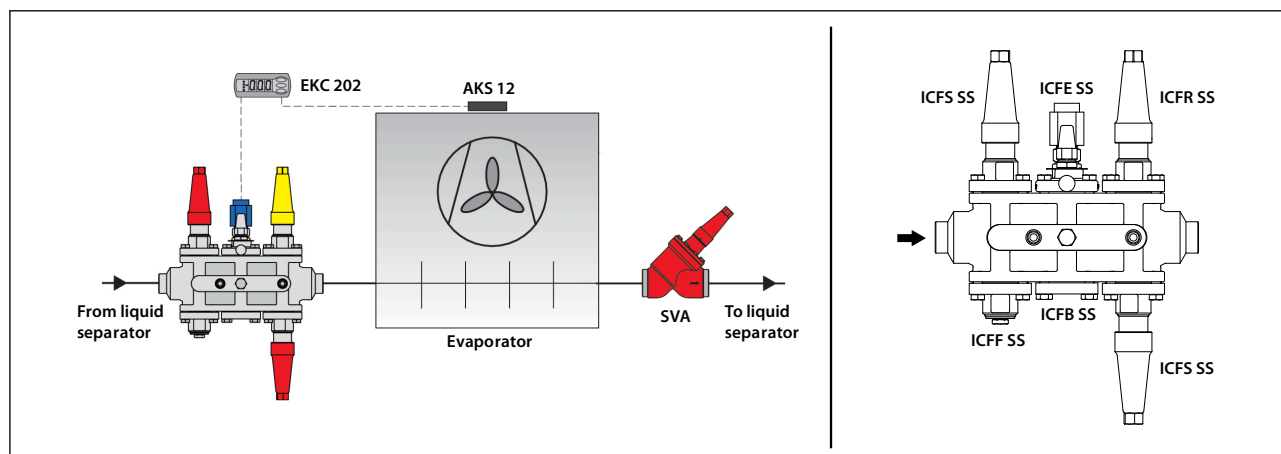

## Valve station, Type ICF SS 20 and ICF SS 25

**NOTE:**

Not all valves are shown. Not to be used for construction purposes.

### Liquid feed line/Hot gas defrost line

Evaporator with soft opening gas powered valve ICLX in the suction line and hot gas defrost featuring: ICF SS liquid feed station and ICF SS Hot gas station with side port to power ICLX. ICS+CVP as a defrost regulator (OFV optional depending on capacity).

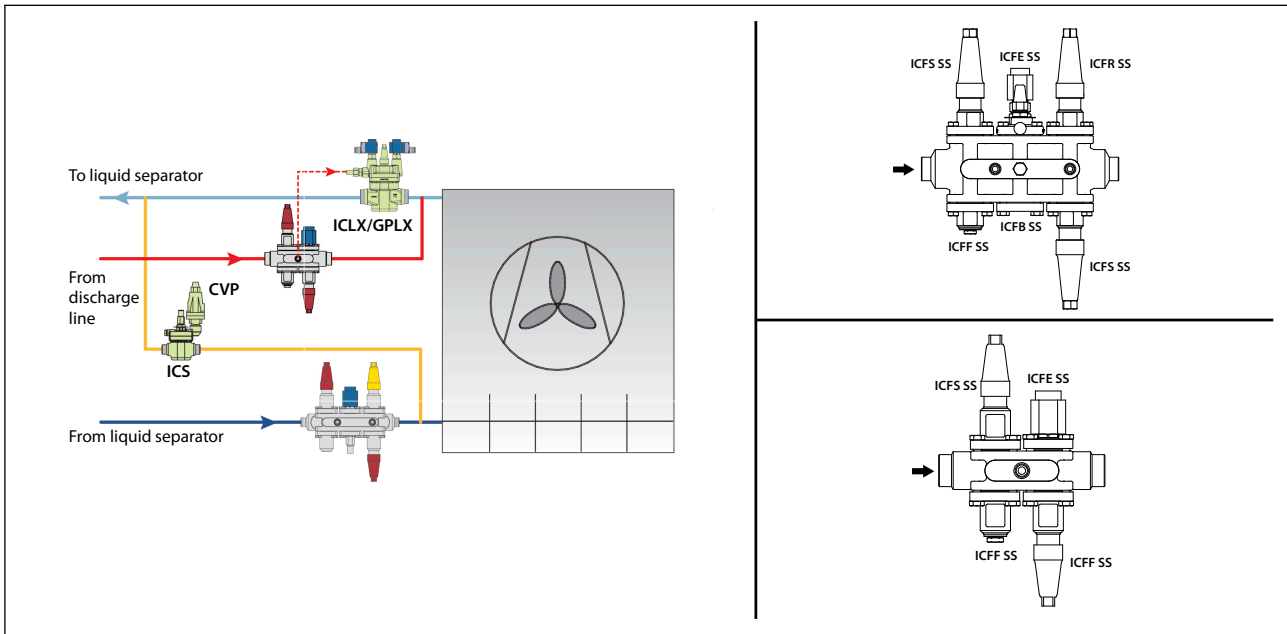

**NOTE:**

Not all valves are shown. Not to be used for construction purposes.

### Liquid injection line

A valve combination for liquid injection to separator with electronic injection valve is required. It is requested to have a solenoid valve in front of the control valve.

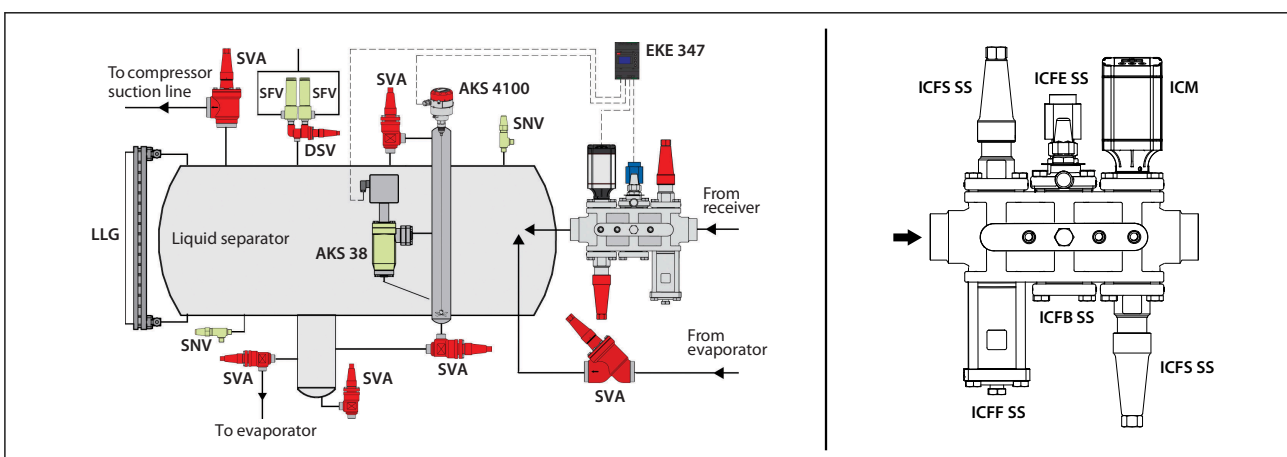

**NOTE:**

Not all valves are shown. Not to be used for construction purposes.

### Liquid injection line

A valve combination for compressor liquid injection with electronic injection valve is required. It is a required to have a solenoid valve in front of the control valve.

## Valve station, Type ICF SS 20 and ICF SS 25

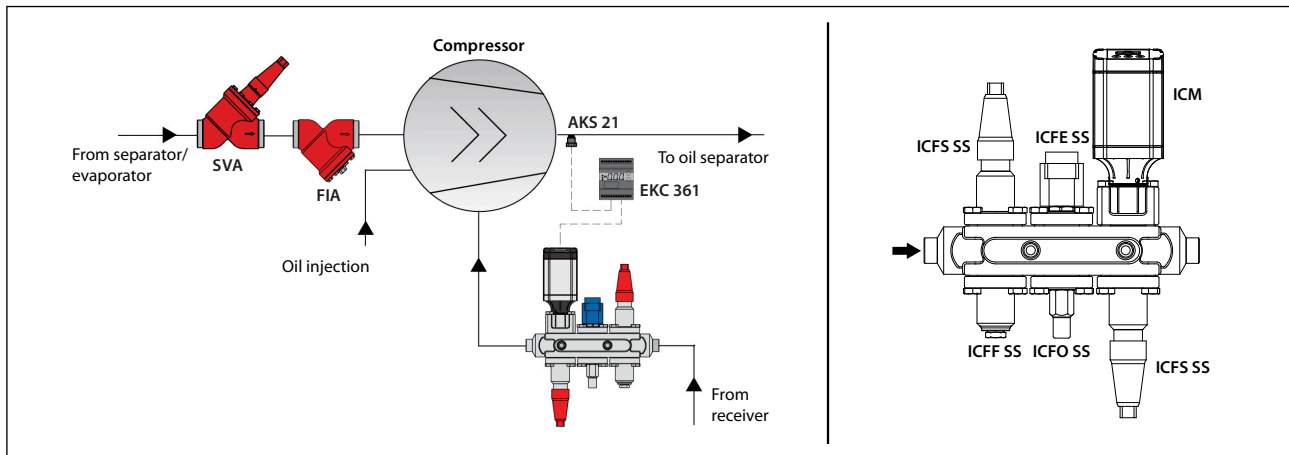

### **NOTE:**

Not all valves are shown. Not to be used for construction purposes.

## Media

### **Refrigerants**

Applicable to HCFC, non flammable HFC, R717 (Ammonia) and R744 (CO<sub>2</sub>). The use of ICF SS valve stations with flammable hydrocarbons is not recommended.

### **New refrigerants**

Danfoss products are continually evaluated for use with new refrigerants depending on market requirements.

When a refrigerant is approved for use by Danfoss, it is added to the relevant portfolio, and the R number of the refrigerant (e.g. R513A) will be added to the technical data of the code number. Therefore, products for specific refrigerants are best checked at [store.danfoss.com/en/](https://store.danfoss.com/en/), or by contacting your local Danfoss representative.

**Product specification**

**Material specification**

**ICF SS housing**

Table 5: ICF SS housing

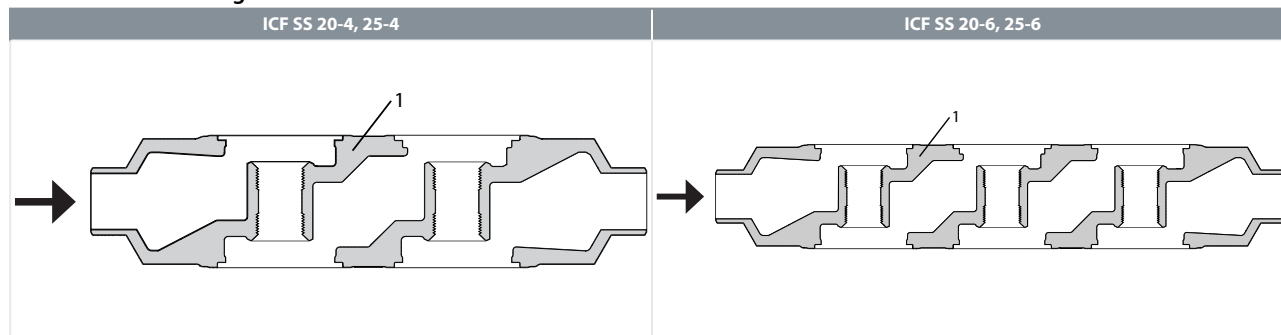

Pos.	Part	Material	EN	ASTM
1	Housing	Stainless steel	GX5CrNi19-10 EN10213-4	A304

**ICFS SS 20 shut-off valve module**

Figure 1: ICFS SS 20 shut-off valve module

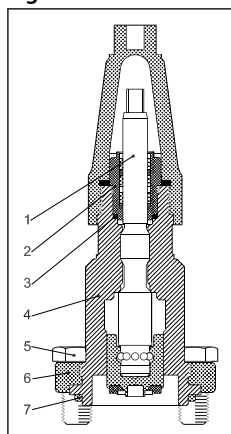

Table 6: ICFS SS 20 shut-off valve module

Pos.	Part	Material	EN	ASTM
1	Spindle	Stainless steel	X8CrNiS 18-9 EN 10088	A303
2	Thread part	Stainless steel		
3	AL-gasket/Refrig. gasket			
4	Bonnet	Stainless steel	X5CrNi 18-10 EN 10272	A304
5	Hex-head bolt M10 × 25	Stainless steel	A2-70	Type 308
6	Flange	Stainless steel	X5CrNi18-10 EN10088	A304
7	Gasket	Fiber non asbestos		

## ICFF SS 20 strainer module

Figure 2: ICFF SS 20 strainer module

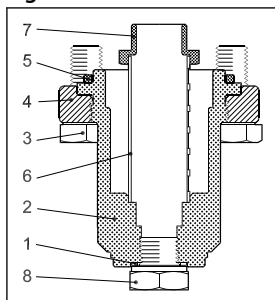

Table 7: ICFF SS 20 strainer module

Pos.	Part	Material	EN	ASTM
1	Gasket	AL 99 F11		
2	Bonnet	Stainless steel	X5CrNi 18-10 EN 10272	A304
3	Hex-head bolt M10 × 25	Stainless steel	A2-70	Type 308
4	Flange	Stainless steel	X5CrNi18-10 EN10088	A304
5	Gasket	Fiber non asbestos		
6	Filter element	Stainless steel 74µ and 150µ		
7	Plug	Steel		
8	Plug 1/4" RG for butt-weld	Stainless steel		

## ICFF SS 20E extended strainer module

Figure 3: ICFF SS 20E extended strainer module

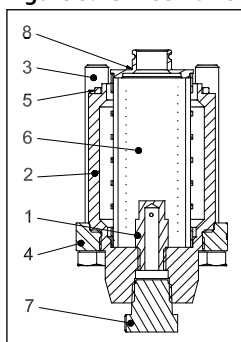

Table 8: ICFF SS 20E extended strainer module

Pos.	Part	Material	EN	ASTM
1	Dirt protection plug	Steel	11SMn30 EN 10087	Grade 1213 A29
2	Bonnet	Stainless steel	X5CrNi 18-10 EN 10272	A304
3	Hex-head bolt M12x80	Stainless steel	A2-70	Type 308
4	Flange	Stainless steel	X5CrNi18-10 EN10088	A304
5	Gasket	Fiber non asbestos		
6	Filter element	Stainless steel 250m		
7	Plug 3/8" NPT	Stainless steel		
8	Filter adaptor	Steel		

## ICFE SS 20 solenoid valve module

Figure 4: ICFE SS 20 solenoid valve module

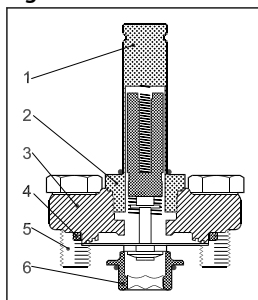

Table 9: ICFE SS 20 solenoid valve module

Pos.	Part	Material	EN	ASTM
1	Armature tube	Stainless steel		
2	Armature tube nut	Stainless steel	X8CrNiS18-9 EN 10088	
3	Flange	Stainless steel	X5CrNi18-10 EN10088	A304
4	Gasket	Fiber non asbestos		
5	Hex-Head bolt M10 × 25	Stainless steel	A2-70	Type 308
6	Seat	High density polymer		

## ICFE SS 20H solenoid valve module

Figure 5: ICFE SS 20H solenoid valve module

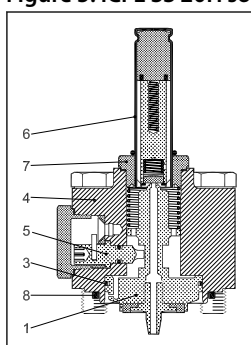

Table 10: ICFE SS 20H solenoid valve module

Pos.	Part	Material	EN	ASTMf
1	Piston	Steel	11SMn30 EN EN 10025	
2	Seat	Teflon		
3	Piston ring			
4	Bonnet cylinder	Stainless steel	X5CrNi18-10 EN10088	A304
5	Manual opener	Steel		
6	Armature tube	Stainless steel		
7	Armature tube nut	Stainless steel	X2CrNi19-11 EN10216	A320
8	Gasket	Fiber non asbestos		

## ICFO SS 20 manual opening module

Figure 6: ICFO SS 20 manual opening module

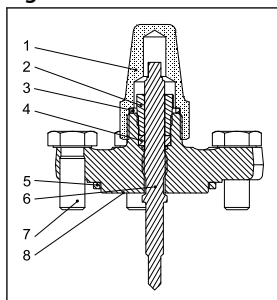

Table 11: ICFO SS 20 manual opening module

Pos.	Part	Material	EN	ASTM
1	Seal cap	Stainless steel		
2	Gland nut	Steel		
3	Seal cap gasket	Nylon	Polyamid A6	Polyamid PA6
4	Sealing ring	Teflon	PTFE	PTFE
5	Gasket	Fiber non asbestos	CR	CR
6	Spindle	Stainless steel	X8CrNiS 18-9 EN 10088	A303
7	Hex-head bolt M10 × 25	Stainless steel	A2-70	Type 308
8	Flange	Stainless steel	X5CrNi18-10 EN10088	A304

## ICFR SS 20 manual regulating valve module, A or B

Figure 7: ICFR SS 20 manual regulating valve module, A or B

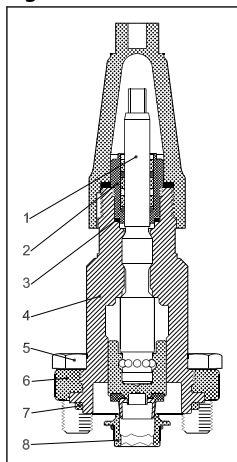

Table 12: ICFR SS 20 manual regulating valve module, A or B

Pos.	Part	Material	EN	ASTM
1	Spindle	Stainless steel	X8CrNiS 18-9 EN 10088	A303
2	Thread part	Stainless steel		
3	AL-gasket			
4	Bonnet	Stainless steel	X5CrNi 18-10 EN 10272	A304
5	Hex-head bolt M10 × 25	Stainless steel	A2-70	Type 308
6	Flange	Stainless steel	X5CrNi18-10 EN10088	A304
7	Gasket	Fiber non asbestos		
8	Seat	High density polymer		

## ICFA SS 20 electronic expansion valve module

Figure 8: ICFA SS 20 electronic expansion valve module

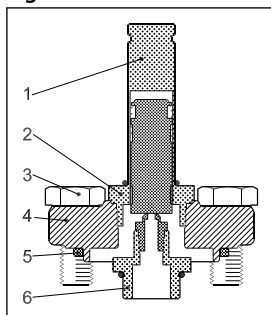

Table 13: ICFA SS 20 electronic expansion valve module

Pos.	Part	Material	EN	ASTM
1	Armature tube	Stainless steel		
2	Armature tube nut	Stainless steel	X8CrNi18-9 EN 10088	
3	Hex-head bolt M10 × 25	Stainless steel	A2-70	Type 308
4	Flange	Stainless steel	X5CrNi18-10 EN10088	A304
5	Gasket	Fiber non asbestos		
6	Adaptor	Stainless steel		

## ICFC SS 20 check valve module

Figure 9: ICFC SS 20 check valve module

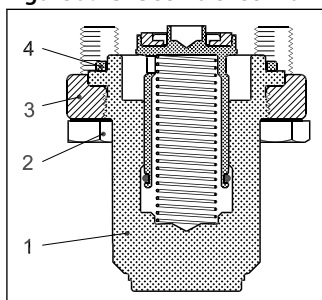

Table 14: ICFC SS 20 check valve module

Pos.	Part	Material	EN	ASTM
1	Bonnet	Stainless steel	X5CrNi 18-10 EN 10272	A304
2	Hex-head bolt M10 × 25	Stainless steel	A2-70	Type 308
3	Flange	Stainless steel	X5CrNi18-10 EN10088	A304
4	Gasket	Fiber non asbestos		

### ICFN SS 20 stop & check valve module

Figure 10: ICFN SS 20 stop & check valve module

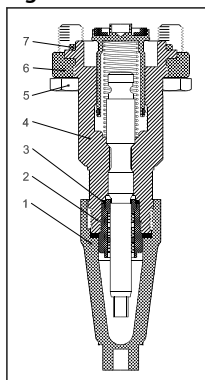

Table 15: ICFN SS 20 stop & check valve module

Pos.	Part	Material	EN	ASTM
1	Spindle	Stainless steel	X8CrNiS 18-9 EN 10088	A303
2	Thread part	Stainless steel		
3	AL-gasket			
4	Bonnet	Stainless steel	X5CrNi 18-10 EN 10272	A304
5	Hex-head bolt M10 × 25	Stainless steel	A2-70	Type 308
6	Flange	Stainless steel	X5CrNi18-10 EN10088	A304
7	Gasket	Fiber non asbestos		

### ICM SS 20-A, 20-B, 20-C, 20-A33 or 20-B66 motor valve module

Figure 11: ICM SS 20-A, 20-B, 20-C, 20-A33 or 20-B66 motor valve module

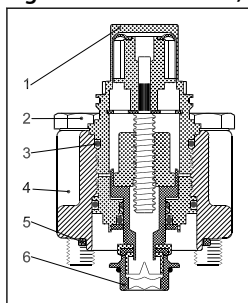

Table 16: ICM SS 20-A, 20-B, 20-C, 20-A33 or 20-B66 motor valve module

Pos.	Part	Material	EN	ASTM
1	Adapter	Stainless steel	X5CrNi18-10 EN 10088	A240
2	Hex-head bolt M10 × 55	Stainless steel	A2-70	Type 308
3	O-ring	Chloroprene		
4	Bonnet	Stainless steel	X5CrNi 18-10 EN 10088	A304
5	Gasket	Fiber non asbestos		
6	Seat	High density polymer		

### ICFB SS 20 blank top cover

Figure 12: ICFB SS 20 blank top cover

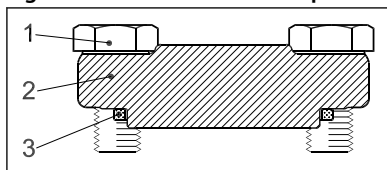

Table 17: ICFB SS 20 blank top cover

Pos.	Part	Material	EN	ASTM
1	Hex-head bolt M10 × 25	Stainless Steel	A2-70	Type 308
2	Flange	Stainless steel	X5CrNi18-10 EN10088	A304
3	Gasket	Fiber non asbestos		

### ICFW SS 20D welding module, 20 DIN

Figure 13: ICFW SS 20D welding module, 20 DIN

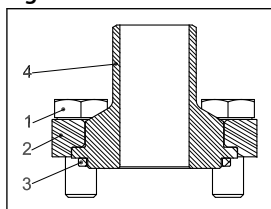

Table 18: ICFW SS 20D welding module, 20 DIN

Pos.	Part	Material	EN	ASTM
1	Hex-head bolt M10 × 25	Stainless Steel	A2-70	Type 308
2	Flange	Stainless steel	X5CrNi18-10 EN10088	A304
3	Gasket	Fiber non asbestos		
4	Weld connection	Stainless Steel		

### ICFS SS 25 shut-off valve module

Figure 14: ICFS SS 25 shut-off valve module

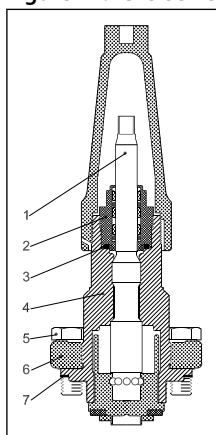

Table 19: ICFS SS 25 shut-off valve module

Pos.	Part	Material	EN	ASTM
1	Spindle	Stainless steel	X8CrNiS 18-9 EN 10088	A303
2	Thread part	Stainless steel		
3	O-ring	Chloroprene		

## Valve station, Type ICF SS 20 and ICF SS 25

Pos.	Part	Material	EN	ASTM
4	Bonnet	Stainless steel	X5CrNi 18-10 EN 10272	A304
5	Hex-head bolt M12 × 30	Stainless steel	A2-70	Type 308
6	Flange	Stainless steel	X5CrNi18-10 EN10088	A304
7	Gasket	Fiber non asbestos		

### ICFF SS 25 strainer module

Figure 15: ICFF SS 25 strainer module

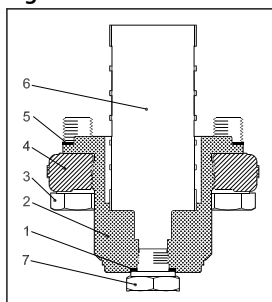

Table 20: ICFF SS 25 strainer module

Pos.	Part	Material	EN	ASTM
1	Al. Gasket	AL 99 F11		
2	Bonnet	Stainless steel	X5CrNi 18-10 EN 10272	A304
3	Hex-head bolt M12 × 30	Stainless steel	A2-70	Type 308
4	Flange	Stainless steel	X5CrNi18-10 EN10088	A304
5	Gasket	Fiber non asbestos		
6	Filter element	Stainless steel 150m		
7	Plug 1/4" RG for butt-weld	Stainless steel		

### ICFF SS 25E extended strainer module

Figure 16: ICFF SS 25E extended strainer module

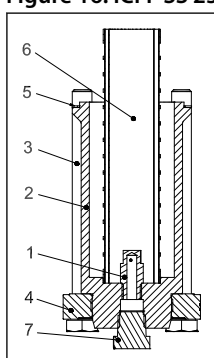

Table 21: ICFF SS 25E extended strainer module

Pos.	Part	Material	EN	ASTM
1	Dirt protection plug	Steel	115Mn30 EN 10087	Grade 1213 A29
2	Bonnet	Stainless steel	X5CrNi 18-10 EN 10222	A304
3	Hex-head bolt M12x140	Stainless steel	A2-70	Type 308
4	Flange	Stainless steel	X5CrNi18-10 EN10088	A304

## Valve station, Type ICF SS 20 and ICF SS 25

Pos.	Part	Material	EN	ASTM
5	Gasket	Fiber non asbestos		
6	Filter element	Stainless steel 250m		
7	Plug 3/8" NPT	Stainless steel		

### ICFE SS 25 solenoid valve module

Figure 17: ICFE SS 25 solenoid valve module

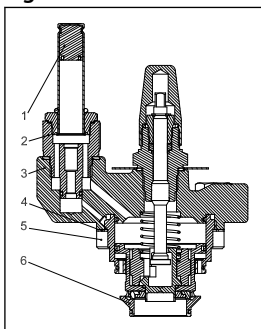

Table 22: ICFE SS 25 solenoid valve module

Pos.	Part	Material	EN	ASTM
1	Armature tube	Stainless steel		
2	Armature tube nut	Stainless steel	X8CrNiS18-9 EN 10088	
3	Bonnet	Stainless steel	X5CrNi 18-10 EN 10222	A304
4	Gasket	Fiber non asbestos		
5	Hex-Head bolt M10 x 30	Stainless steel	A2-70	Type 308
6	Seat	High density polymer		

### ICFR SS 25 manual regulating valve module, A or B

Figure 18: ICFR SS 25 manual regulating valve module, A or B

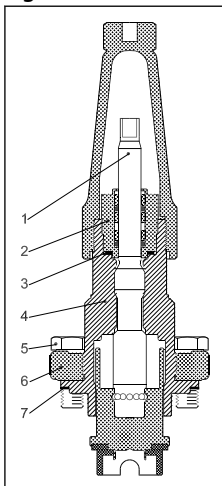

Table 23: ICFR SS 25 manual regulating valve module, A or B

Pos.	Part	Material	EN	ASTM
1	Spindle	Stainless steel	X8CrNiS 18-9 EN 10088	A303
2	Thread part	Stainless steel		
3	O-ring	Chloroprene		
4	Bonnet	Stainless steel	X5CrNi 18-10 EN 10272	A304
5	Hex-head bolt M12 x 30	Stainless steel	A2-70	Type 308

## Valve station, Type ICF SS 20 and ICF SS 25

Pos.	Part	Material	EN	ASTM
6	Flange	Stainless steel	X5CrNi18-10 EN10088	A304
7	Gasket	Fiber non asbestos		
8	Seat	High density polymer		

### ICFC SS 25 check valve module

Figure 19: ICFC SS 25 check valve module

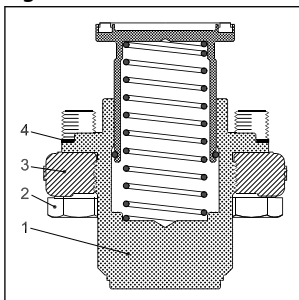

Table 24: ICFC SS 25 check valve module

Pos.	Part	Material	EN	ASTM
1	Bonnet	Stainless steel	X5CrNi 18-10 EN 10272	A304
2	Hex-head bolt M12 × 30	Stainless steel	A2-70	Type 308
3	Flange	Stainless steel	X5CrNi18-10 EN10088	A304
4	Gasket	Fiber non asbestos		

### ICFN SS 25 stop & check valve module

Figure 20: ICFN SS 25 stop & check valve module

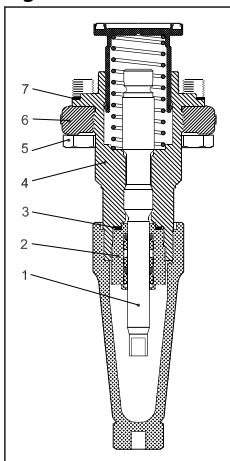

Table 25: ICFN SS 25 stop & check valve module

Pos.	Part	Material	EN	ASTM
1	Spindle	Stainless steel	X8CrNiS 18-9 EN 10088	A303
2	Thread part	Stainless steel		
3	O-ring	Chloroprene		
4	Bonnet	Stainless steel	X5CrNi 18-10 EN 10272	A304
5	Hex-head bolt M12 × 30	Stainless steel	A2-70	Type 308
6	Flange	Stainless steel	X5CrNi18-10 EN10088	A304
7	Gasket	Fiber non asbestos		

### ICM SS 25-A or B motor valve module

Figure 21: ICM SS 25-A or B motor valve module

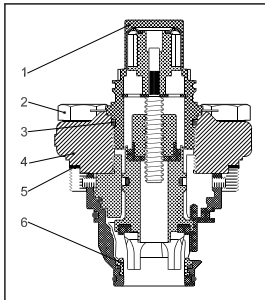

Table 26: ICM SS 25-A or B motor valve module

Pos.	Part	Material	EN	ASTM
1	Adapter	Stainless steel	X5CrNi18-10 EN 10088	A240
2	Hex-head bolt M12 × 30	Stainless steel	A2-70	Type 308
3	O-ring	Chloroprene		
4	Bonnet	Stainless steel	X5CrNi18-10 EN10088	A304
5	Gasket	Fiber non asbestos		
6	Seat	High density polymer		

### ICFB SS 25 blank top cover

Figure 22: ICFB SS 25 blank top cover

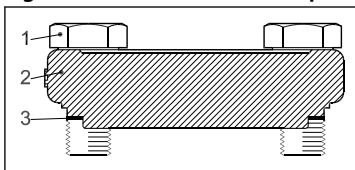
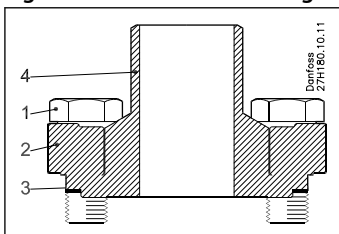

Table 27: ICFB SS 25 blank top cover

Pos.	Part	Material	EN	ASTM
1	Hex-head bolt M10 × 30	Stainless Steel	A2-70	Type 308
2	Flange	Stainless steel	X5CrNi18-10 EN10088	A304
3	Gasket	Fiber non asbestos		

### ICFW SS 25 welding module, 25 DIN

Figure 23: ICFW SS 25 welding module, 25 DIN



**Table 28: ICFW SS 25 welding module, 25 DIN**

Pos.	Part	Material	EN	ASTM
1	Hex-head bolt M10 × 30	Stainless Steel	A2-70	Type 308
2	Flange	Stainless steel	X5CrNi18-10 EN10088	A304
3	Gasket	Fiber non asbestos		
4	Weld connection	Stainless steel		

## Connections

### D: Butt-weld DIN (EN 10220)

**Figure 24: D: Butt-weld DIN (EN 10220)**

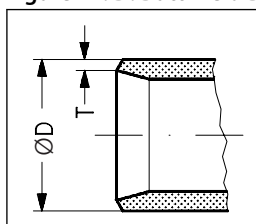
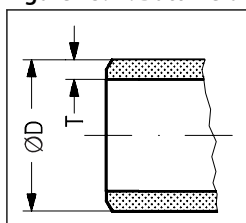

**Table 29: D: Butt-weld DIN (EN 10220)**

Size	Size	ØD	T	ØD	T
mm	in.	mm	mm	in.	in.
20	(3/4)	26.9	2.3	1.059	0.091
25	1	33.7	2.6	1.327	0.103
32	(1 1/4)	42.4	2.6	1.669	0.102
40	1 1/2	48.3	2.6	1.902	0.103

### A: Butt-weld ANSI (B 36.19)

**Figure 25: A: Butt-weld ANSI (B 36.19)**



**Table 30: A: Butt-weld ANSI (B 36.19)**

Size	Size	ØD	T	ØD	T	Schedule
mm	in.	mm	mm	in.	in.	
20	(3/4)	26.9	2.9	1.059	0.11	40
25	1	33.7	3.5	1.327	0.14	40
32	1 1/4	42.4	3.6	1.669	0.14	40
40	1 1/2	48.3	3.7	1.902	0.15	40

## Dimensions and weights

### ICF SS 20-6

Figure 26: ICF SS 20-6

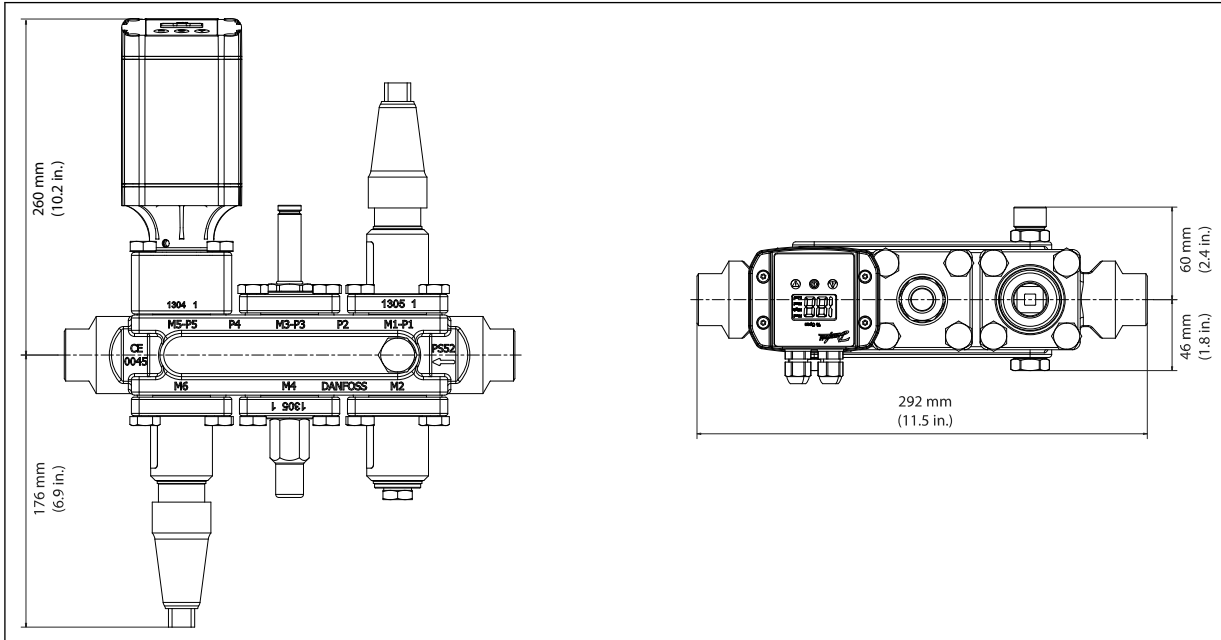

This example indicates the maximum dimensions for the ICF SS valve stations.

### ICF SS 20-4

Figure 27: ICF SS 20-4

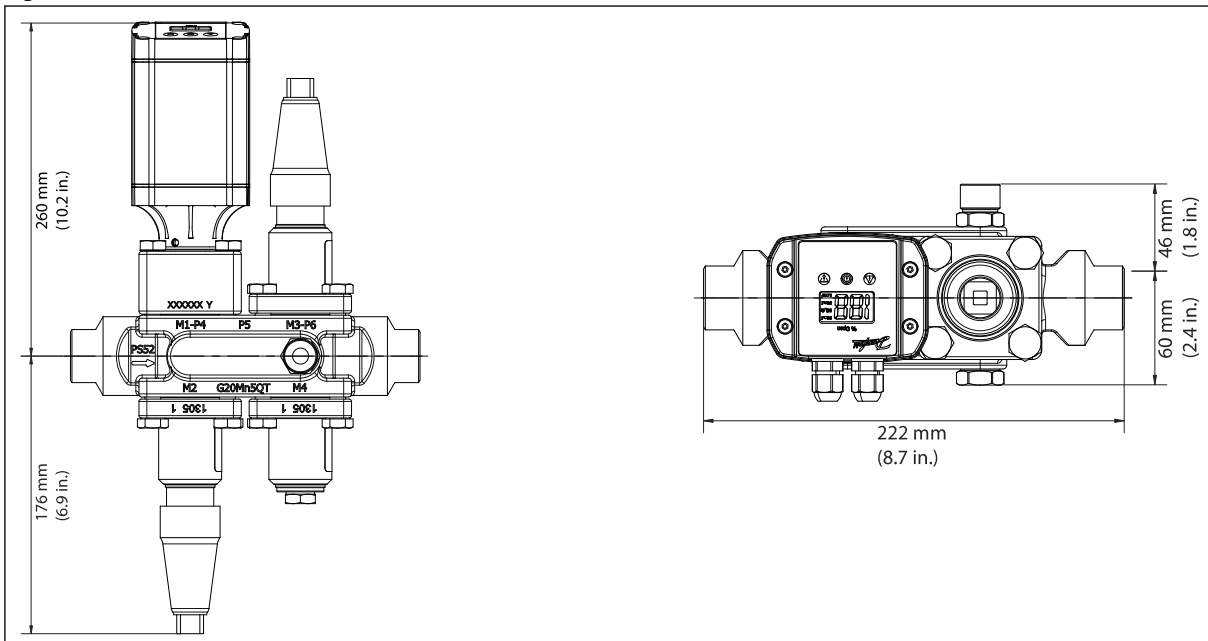

ICF SS 25-6

Figure 28: ICF SS 25-6

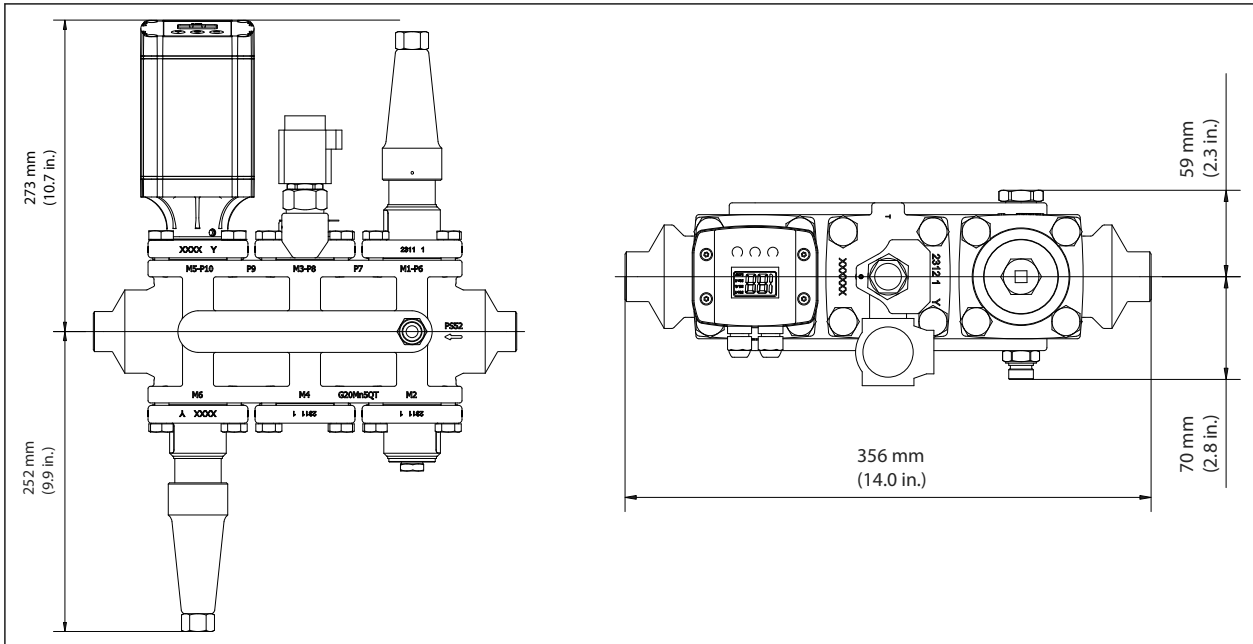

ICF SS 25-4

Figure 29: ICF SS 25-4

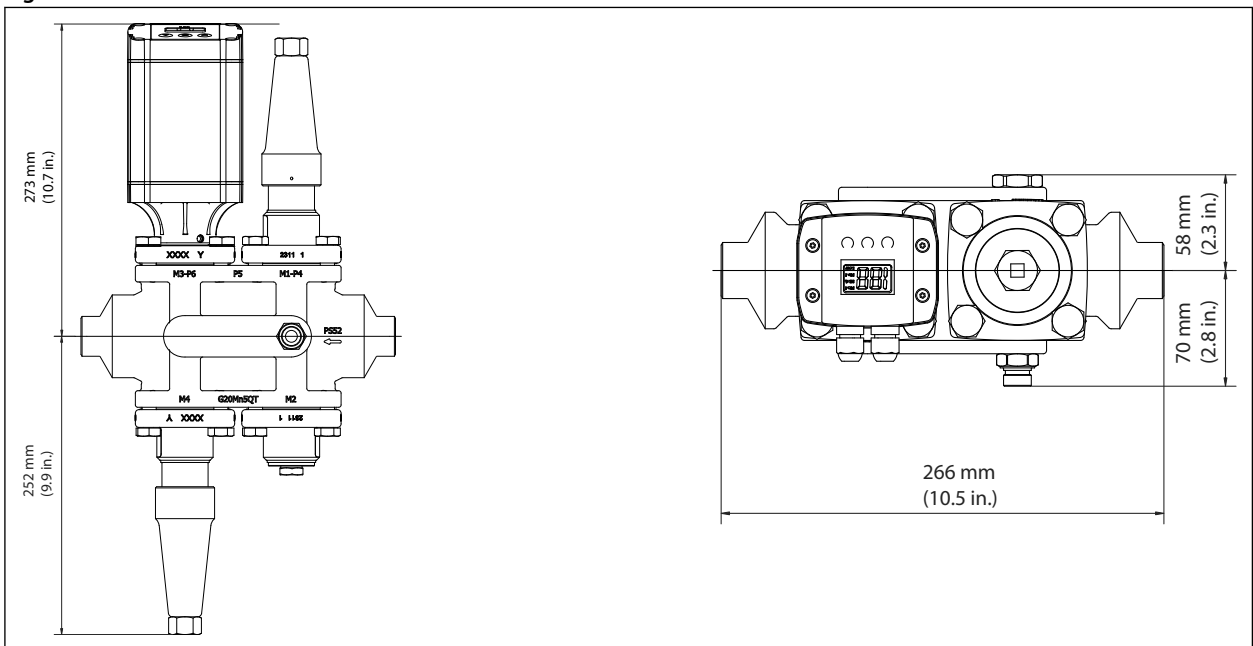

## Ordering

Below Nomenclature show the generic configuration and application by identification of housing size, type and application group.

This designation is often used for discussion on possible solutions and will be the final identification on the valve label (see label example).

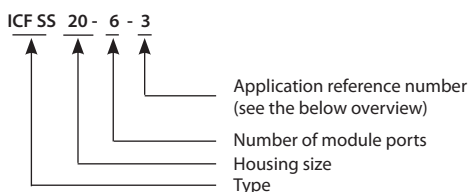

Figure 30: Label example:



For ordering, connection size and type must be chosen to get the final identification. **The final identification is done by code number only.** See (Page 20 to Page 25)

### Code number selection

To determine the correct ICF SS valve station follow steps 1 through 5.

#### Step 1 Determine application and function requirements

- **Line:** Pumped liquid, Liquid Injection, Hot gas defrost, Liquid DX etc
- **Control:** On/off solenoid valve, motorised valve
- **Defrost:** Electric or hot gas

**NOTE:**

From the above determine the application reference number. See (Page 20 to Page 25)

#### Step 2 Selection criteria - Please use Coolselector<sup>®</sup>2

Download the software from: <http://refrigerationandairconditioning.danfoss.com/support-center/apps-and-software/coolselector/>

- Refrigerant
- Capacity
- Temperature
- Circulation rate

**NOTE:**

From the above determine the valve station required, e.g.: **ICF SS 20** complete with **ICM SS 20-C**

#### Step 3 Establish connection sizes and type

- DIN butt-weld / ANSI butt-weld
- 20 (¾ in.), 25 (1 in.), 32 (1 ¼ in.) or 40 (1 ½ in.)

**Step 4 Establish code number.** See (Page 20 to Page 25)

### Liquid feed

Table 31: Application 1: Liquid feed (no hot gas defrost)

Type	# of modules	Appl. #	Connection size		Connection type	Module location						Weight		Code number
			[in.]	[mm]		M1	M2	M3	M4	M5	M6	kg	lbs	
ICF SS 20	6	1RA	¾	20	Butt-weld DIN-EN 10220	ICFS 20	ICFF 20	ICFE 20	ICFO 20	ICFR 20A	ICFS 20	9.5	20.9	<b>027L4700</b>
ICF SS 20	6	1RA	1	25	Butt-weld DIN-EN 10220	ICFS 20	ICFF 20	ICFE 20	ICFO 20	ICFR 20A	ICFS 20	9.7	21.3	<b>027L4701</b>
ICF SS 20	6	1RA	¾	20	Butt-weld ANSI (B 36.19)	ICFS 20	ICFF 20	ICFE 20	ICFO 20	ICFR 20A	ICFS 20	10.4	22.9	<b>027L3555</b>

## Valve station, Type ICF SS 20 and ICF SS 25

Type	# of modules	Appl. #	Connection size		Connection type	Module location						Weight		Code number
			[in.]	[mm]		M1	M2	M3	M4	M5	M6	kg	lbs	
ICF SS 20	6	1RA	1	25	Butt-weld ANSI (B 36.19)	ICFS 20	ICFF 20E	ICFE 20	ICFO 20	ICFR 20A	ICFS 20	9.9	21.8	027L3556
ICF SS 20	6	1HRB	1	25	Butt-weld ANSI (B 36.19)	ICFS 20	ICFF 20E	ICFE 20H	ICFB 20	ICFR 20B	ICFS 20	10.9	24	027L3578
ICF SS 20	6	1HRB	1¼	32	Butt-weld ANSI (B 36.19)	ICFS 20	ICFF 20E	ICFE 20H	ICFB 20	ICFR 20B	ICFS 20	10.9	24	027L3557
ICF SS 25	6	1RA	1	25	Butt-weld ANSI (B 36.19)	ICFS 25	ICFF 25E	ICFE 25	ICFB 25	ICFR 25A	ICFS 25	24.1	53	027L3568
ICF SS 25	6	1RA	1¼	32	Butt-weld ANSI (B 36.19)	ICFS 25	ICFF 25E	ICFE 25	ICFB 25	ICFR 25A	ICFS 25	23.8	52.4	027L3569
ICF SS 25	6	1RB	1¼	32	Butt-weld ANSI (B 36.19)	ICFS 25	ICFF 25E	ICFE 25	ICFB 25	ICFR 25B	ICFS 25	24.2	53.2	027L3584
ICF SS 25	6	1RB	1½	40	Butt-weld ANSI (B 36.19)	ICFS 25	ICFF 25E	ICFE 25	ICFB 25	ICFR 25B	ICFS 25	23.8	52.4	027L3570

Table 32: Application 2: Liquid feed

Type	# of modules	Appl. #	Connection size		Connection type	Module location						Weight		Code number
			[in.]	[mm]		M1	M2	M3	M4	M5	M6	kg	lbs	
ICF SS 20	6	2RA	¾	20	Butt-weld DIN-EN 10220	ICFS 20	ICFF 20	ICFE 20	ICFO 20	ICFR 20A	ICFN 20	10	22.1	027L3428
ICF SS 20	6	2RA	1	25	Butt-weld DIN-EN 10220	ICFS 20	ICFF 20E	ICFE 20	ICFO 20	ICFR 20A	ICFN 20	10	22.1	027L3445
ICF SS 20	6	2RA	1	25	Butt-weld DIN-EN 10220	ICFS 20	ICFF 20	ICFE 20	ICFO 20	ICFR 20A	ICFN 20	9.7	21.3	027L4758
ICF SS 20	6	2HRB	1¼	32	Butt-weld DIN-EN 10220	ICFS 20	ICFF 20	ICFE 20H	ICFB 20	ICFR 20B	ICFN 20	9.2	20.2	027L4759
ICF SS 25	6	2RB	1¼	32	Butt-weld DIN-EN 10220	ICFS 25	ICFF 25	ICFE 25	ICFB 25	ICFR 25B	ICFN 25	23.9	52.6	027L4766
ICF SS 20	6	2RA	¾	20	Butt-weld ANSI (B 36.19)	ICFS 20	ICFF 20E	ICFE 20	ICFO 20	ICFR 20A	ICFN 20	10.1	22.2	027L3571
ICF SS 20	6	2RA	1	25	Butt-weld ANSI (B 36.19)	ICFS 20	ICFF 20E	ICFE 20	ICFO 20	ICFR 20A	ICFN 20	9.9	21.8	027L3572

Table 33: Application 3: Liquid feed

Type	# of modules	Appl. #	Connection size		Connection type	Module location						Weight		Code number
			[in.]	[mm]		M1	M2	M3	M4	M5	M6	kg	lbs	
ICF SS 20	6	3RA	¾	20	Butt-weld DIN-EN 10220	ICFS 20	ICFF 20	ICFE 20	ICFC 20	ICFR 20A	ICFS 20	9.6	21.1	027L4702
ICF SS 20	6	3RA	1	25	Butt-weld DIN-EN 10220	ICFS 20	ICFF 20	ICFE 20	ICFC 20	ICFR 20A	ICFS 20	9.7	21.3	027L4703
ICF SS 20	6	3HRA	1	25	Butt-weld DIN-EN 10220	ICFS 20	ICFF 20	ICFE 20H	ICFC 20	ICFR 20A	ICFS 20	10.6	23.3	027L4717
ICF SS 25	6	3RA	1	25	Butt-weld DIN-EN 10220	ICFS 25	ICFF 25	ICFE 25	ICFC 25	ICFR 25A	ICFS 25	23.4	51.5	027L4724
ICF SS 25	6	3RA	1¼	32	Butt-weld DIN-EN 10220	ICFS 25	ICFF 25	ICFE 25	ICFC 25	ICFR 25A	ICFS 25	23.2	51	027L4760
ICF SS 25	6	3RB	1¼	32	Butt-weld DIN-EN 10220	ICFS 25	ICFF 25	ICFE 25	ICFC 25	ICFR 25B	ICFS 25	23.8	52.4	027L4725
ICF SS 25	6	3RB	1½	40	Butt-weld DIN-EN 10220	ICFS 25	ICFF 25	ICFE 25	ICFC 25	ICFR 25B	ICFS 25	24	52.8	027L4761
ICF SS 25	6	3RB	1½	40	Butt-weld DIN-EN 10220	ICFS 25	ICFF 25E	ICFE 25	ICFC 25	ICFR 25B	ICFS 25	24.7	54.3	027L4191
ICF SS 20	6	3HRB	¾	20	Butt-weld ANSI (B 36.19)	ICFS 20	ICFF 20E	ICFE 20H	ICFC 20	ICFR 20B	ICFS 20	10.7	23.5	027L3579
ICF SS 20	6	3HRB	1	25	Butt-weld ANSI (B 36.19)	ICFS 20	ICFF 20E	ICFE 20H	ICFC 20	ICFR 20B	ICFS 20	11.2	24.6	027L3580
ICF SS 20	6	3HRB	1¼	32	Butt-weld ANSI (B 36.19)	ICFS 20	ICFF 20E	ICFE 20H	ICFC 20	ICFR 20B	ICFS 20	11.3	24.9	027L3581
ICF SS 25	6	3RA	1	25	Butt-weld ANSI (B 36.19)	ICFS 25	ICFF 25E	ICFE 25	ICFC 25	ICFR 25A	ICFS 25	24.2	53.2	027L3585

## Valve station, Type ICF SS 20 and ICF SS 25

Type	# of modules	Appl. #	Connection size		Connection type	Module location						Weight		Code number
			[in.]	[mm]		M1	M2	M3	M4	M5	M6	kg	lbs	
ICF SS 25	6	3RA	1¼	32	Butt-weld ANSI (B 36.19)	ICFS 25	ICFF 25E	ICFE 25	ICFC 25	ICFR 25A	ICFS 25	24.1	53	027L3586
ICF SS 25	6	3RB	1¼	32	Butt-weld ANSI (B 36.19)	ICFS 25	ICFF 25E	ICFE 25	ICFC 25	ICFR 25B	ICFS 25	24.1	53	027L3587
ICF SS 25	6	3RB	1½	40	Butt-weld ANSI (B 36.19)	ICFS 25	ICFF 25E	ICFE 25	ICFC 25	ICFR 25B	ICFS 25	24.2	53.2	027L3588

**Table 34: Application 10: Liquid feed (no hot gas defrost)**

Type	# of modules	Appl. #	Connection size		Connection type	Module location				Weight		Code number
			[in.]	[mm]		M1	M2	M3	M4	kg	lbs	
ICF SS 20	4	10RA	¾	20	Butt-weld DIN-EN 10220	ICFS 20	ICFF 20	ICFE 20	ICFR 20B	7.4	16.2	027L3440
ICF SS 20	4	10RA	1	25	Butt-weld DIN-EN 10220	ICFS 20	ICFF 20	ICFE 20	ICFR 20A	7.2	15.8	027L4709
ICF SS 25	4	10RA	1	25	Butt-weld DIN-EN 10220	ICFS 25	ICFF 25	ICFE 25	ICFR 25A	15.9	35	027L4731
ICF SS 25	4	10RB	1¼	32	Butt-weld DIN-EN 10220	ICFS 25	ICFF 25	ICFE 25	ICFR 25B	15.4	33.9	027L4732
ICF SS 25	4	10RA	1	25	Butt-weld DIN-EN 10220	ICFS 25	ICFF 25E	ICFE 25	ICFR 25A	16.2	35.7	027L4590
ICF SS 20	4	10HRB	¾	20	Butt-weld ANSI (B 36.19)	ICFS 20	ICFF 20E	ICFE 20H	ICFR 20B	8.4	18.5	027L3582
ICF SS 20	4	10HRB	1	25	Butt-weld ANSI (B 36.19)	ICFS 20	ICFF 20E	ICFE 20H	ICFR 20B	7.8	17.2	027L3583
ICF SS 25	4	10RA	1	25	Butt-weld ANSI (B 36.19)	ICFS 25	ICFF 25E	ICFE 25	ICFR 25A	15.8	34.8	027L3592
ICF SS 25	4	10RB	1¼	32	Butt-weld ANSI (B 36.19)	ICFS 25	ICFF 25E	ICFE 25	ICFR 25B	16.2	35.6	027L3593
ICF SS 25	4	10RB	1½	40	Butt-weld ANSI (B 36.19)	ICFS 25	ICFF 25E	ICFE 25	ICFR 25B	16.2	35.6	027L3594

**Table 35: Application 15: Liquid feed with external connection**

Type	# of modules	Appl. #	Connection size		Connection type	Module location						Weight		Code number
			[in.]	[mm]		M1	M2	M3	M4	M5	M6	kg	lbs	
ICF SS 25	6	15RA	1	25	Butt-weld DIN-EN 10220	ICFS 25	ICFF 25	ICFE 25	ICFC 25	ICFW 25D	ICFR 25A	21.8	48	027L4733
ICF SS 25	6	15RB	1¼	32	Butt-weld DIN-EN 10220	ICFS 25	ICFF 25	ICFE 25	ICFC 25	ICFW 25D	ICFR 25B	22.7	49.9	027L4734

**NOTE:**

ICAD and coils are not included and must be ordered separately.

When used in systems with CO<sub>2</sub>, the o-rings on the ICM module can swell (grow). At service, it is therefore recommended to install new o-rings, before the ICM function module is re-installed in the ICF SS valve body. ICAD and coils are not included and must be ordered separately.

## Liquid injection

**Table 36: Application 5: Liquid injection (expansion)**

Type	# of modules	Appl. #	Connection size		Connection type	Module location						Weight		Code number
			[in.]	[mm]		M1	M2	M3	M4	M5	M6	kg	lbs	
ICF SS 20	6	5MA33	¾	20	Butt-weld DIN-EN 10220	ICFS 20	ICFF 20-74	ICFE 20	ICFO 20	ICM 20-A33	ICFS 20	9.8	21.6	027L4714
ICF SS 20	6	5MB66	¾	20	Butt-weld DIN-EN 10220	ICFS 20	ICFF 20	ICFE 20	ICFO 20	ICM 20-B66	ICFS 20	10.1	22.3	027L3443
ICF SS 20	6	5MA	1	25	Butt-weld DIN-EN 10220	ICFS 20	ICFF 20	ICFE 20	ICFO 20	ICM 20-A	ICFS 20	9.8	21.6	027L4704
ICF SS 20	6	5MB	1	25	Butt-weld DIN-EN 10220	ICFS 20	ICFF 20	ICFE 20	ICFO 20	ICM 20-B	ICFS 20	9.6	21.1	027L4705
ICF SS 20	6	5HMB	1	25	Butt-weld DIN-EN 10220	ICFS 20	ICFF 20	ICFE 20H	ICFB 20	ICM 20-B	ICFS 20	11.4	25.1	027L4718

## Valve station, Type ICF SS 20 and ICF SS 25

Type	# of modules	Appl. #	Connection size		Connection type	Module location						Weight		Code number
			[in.]	[mm]		M1	M2	M3	M4	M5	M6	kg	lbs	
ICF SS 20	6	5MA33	1	25	Butt-weld DIN-EN 10220	ICFS 20	ICFF 20	ICFE 20	ICFO 20	ICM 20-A33	ICFS 20	9.6	21.1	027L4755
ICF SS 25	6	5MA	1	25	Butt-weld DIN-EN 10220	ICFS 25	ICFF 25	ICFE 25	ICFB 25	ICM 25-A	ICFS 25	22.8	50.2	027L4726
ICF SS 20	6	5MB66	1¼	32	Butt-weld DIN-EN 10220	ICFS 20	ICFF 20	ICFE 20	ICFO 20	ICM 20-B66	ICFS 20	9.6	21.1	027L4754
ICF SS 20	6	5HMB	1¼	32	Butt-weld DIN-EN 10220	ICFS 20	ICFF 20	ICFE 20H	ICFB 20	ICM 20-B	ICFS 20	10.2	22.4	027L4756
ICF SS 20	6	5MC	1½	32	Butt-weld DIN-EN 10220	ICFS 20	ICFF 20	ICFE 20	ICFO 20	ICM 20-C	ICFS 20	9.8	21.6	027L4706
ICF SS 20	6	5HMC	1¼	32	Butt-weld DIN-EN 10220	ICFS 20	ICFF 20	ICFE 20H	ICFB 20	ICM 20-C	ICFS 20	10.3	22.7	027L4719
ICF SS 25	6	5MB	1¼	32	Butt-weld DIN-EN 10220	ICFS 25	ICFF 25	ICFE 25	ICFB 25	ICM 25-B	ICFS 25	22.3	49	027L4727
ICF SS 25	6	5MB	1½	40	Butt-weld DIN-EN 10220	ICFS 25	ICFF 25	ICFE 25	ICFB 25	ICM 25-B	ICFS 25	22.3	49	027L4728
ICF SS 25	6	5MA	1½	40	Butt-weld DIN-EN 10220	ICFS 25	ICFF 25	ICFE 25	ICFB 25	ICM 25-A	ICFS 25	22.3	49	027L4735
ICF SS 20	6	5MA33	¾	20	Butt-weld ANSI (B 36.19)	ICFS 20	ICFF 20E	ICFE 20	ICFO 20	ICM 20-A33	ICFS 20	10.1	22.2	027L3573
ICF SS 20	6	5MA	¾	20	Butt-weld ANSI (B 36.19)	ICFS 20	ICFF 20E	ICFE 20	ICFO 20	ICM 20-A	ICFS 20	10	22	027L3574
ICF SS 20	6	5MA	1	25	Butt-weld ANSI (B 36.19)	ICFS 20	ICFF 20E	ICFE 20	ICFO 20	ICM 20-A	ICFS 20	10.1	22.2	027L3575
ICF SS 20	6	5MB	¾	20	Butt-weld ANSI (B 36.19)	ICFS 20	ICFF 20E	ICFE 20	ICFO 20	ICM 20-B	ICFS 20	9.8	21.6	027L3576
ICF SS 20	6	5MB	1	25	Butt-weld ANSI (B 36.19)	ICFS 20	ICFF 20E	ICFE 20	ICFO 20	ICM 20-B	ICFS 20	10	22	027L3577
ICF SS 25	6	5MA	1	25	Butt-weld ANSI (B 36.19)	ICFS 25	ICFF 25E	ICFE 25	ICFB 25	ICM 25-A	ICFS 25	23.1	50.8	027L3589
ICF SS 25	6	5MA	1¼	32	Butt-weld ANSI (B 36.19)	ICFS 25	ICFF 25E	ICFE 25	ICFB 25	ICM 25-A	ICFS 25	23.2	51	027L3590
ICF SS 25	6	5MA33	1½	40	Butt-weld ANSI (B 36.19)	ICFS 25	ICFF 25-E	ICFE 25	ICFB 25	ICM 25-A33	ICFS 25	23.1	50.8	027L3591

**Table 37: Application 14: Liquid injection (expansion)**

Type	# of modules	Appl. #	Connection size		Connection type	Module location				Weight		Code number
			[in.]	[mm]		M1	M2	M3	M4	kg	lbs	
ICF SS 20	4	14MA	¾	20	Butt-weld DIN-EN 10220	ICFS 20	ICFF 20	ICM 20-A	ICFS 20	7.3	16.1	027L4710
ICF SS 20	4	14MA	¾	20	Butt-weld DIN-EN 10220	ICFS 20	ICFF 20E	ICM 20-A	ICFS 20	6.9	15.1	027L3444
ICF SS 20	4	14MB	1	25	Butt-weld DIN-EN 10220	ICFS 20	ICFF 20	ICM 20-B	ICFS 20	7.2	15.8	027L4711
ICF SS 20	4	14MB66	1	25	Butt-weld DIN-EN 10220	ICFS 20	ICFF 20	ICM 20-B66	ICFS 20	7	15.4	027L4722
ICF SS 20	4	14MC	1¼	32	Butt-weld DIN-EN 10220	ICFS 20	ICFF 20	ICM 20-C	ICFS 20	7.3	16.1	027L4712
ICF SS 25	4	14MB	1	25	Butt-weld DIN-EN 10220	ICFS 25	ICFF 25	ICM 25-B	ICFS 25	14.8	32.5	027L4765
ICF SS 25	4	14MB	1¼	32	Butt-weld DIN-EN 10220	ICFS 25	ICFF 25	ICM 25-B	ICFS 25	14.8	32.5	027L4764

**NOTE:**

ICAD and coils are not included and must be ordered separately.

When used in systems with CO<sub>2</sub>, the o-rings on the ICM module can swell (grow). At service, it is therefore recommended to install new o-rings, before the ICM function module is re-installed in the ICF SS valve body. ICAD and coils are not included and must be ordered separately.

## Hot gas defrost

Table 38: Application 9: Hot gas defrost

Type	# of modules	Appl. #	Connection size		Connection type	Module location				Weight		Code number
			[in.]	[mm]		M1	M2	M3	M4	kg	lbs	
ICF SS 20	4	9	1	25	Butt-weld DIN-EN 10220	ICFS 20	ICFF 20	ICFE 20	ICFS 20	7.2	15.8	027L4707
ICF SS 20	4	9H	1	25	Butt-weld DIN-EN 10220	ICFS 20	ICFF 20	ICFE 20H	ICFS 20	8.2	18	027L4720
ICF SS 20	4	9	1¼	32	Butt-weld DIN-EN 10220	ICFS 20	ICFF 20	ICFE 20	ICFS 20	6.8	15	027L4708
ICF SS 20	4	9H	1¼	32	Butt-weld DIN-EN 10220	ICFS 20	ICFF 20	ICFE 20H	ICFS 20	7.6	16.7	027L4721
ICF SS 25	4	9	1	25	Butt-weld DIN-EN 10220	ICFS 25	ICFF 25	ICFE 25	ICFS 25	16.2	35.7	027L3429
ICF SS 25	4	9	1¼	32	Butt-weld DIN-EN 10220	ICFS 25	ICFF 25	ICFE 25	ICFS 25	15.7	34.5	027L4729
ICF SS 25	4	9	1½	40	Butt-weld DIN-EN 10220	ICFS 25	ICFF 25	ICFE 25	ICFS 25	15.7	34.5	027L4730
ICF SS 25	4	9	1½	40	Butt-weld DIN-EN 10220	ICFS 25	ICFW 25D	ICM 25-B	ICFS 25	16.6	36.6	027L4190
ICF SS 20	4	9H	¾	20	Butt-weld ANSI (B 36.19)	ICFS 20	ICFF 20E	ICFE 20H	ICFS 20	8	17.6	027L3552
ICF SS 20	4	9H	1	25	Butt-weld ANSI (B 36.19)	ICFS 20	ICFF 20E	ICFE 20H	ICFS 20	8.1	17.8	027L3553
ICF SS 20	4	9H	1¼	32	Butt-weld ANSI (B 36.19)	ICFS 20	ICFF 20E	ICFE 20H	ICFS 20	7.9	17.4	027L3554
ICF SS 25	4	9	1	25	Butt-weld ANSI (B 36.19)	ICFS 25	ICFF 25E	ICFE 25	ICFS 25	16	35.2	027L3565
ICF SS 25	4	9	1¼	32	Butt-weld ANSI (B 36.19)	ICFS 25	ICFF 25E	ICFE 25	ICFS 25	16	35.2	027L3566
ICF SS 25	4	9	1½	40	Butt-weld ANSI (B 36.19)½	ICFS 25	ICFF 25E	ICFE 25	ICFS 25	16.1	35.4	027L3567

## Miscellaneous

Table 39: Application 90: Miscellaneous

Type	# of modules	Appl. #	Connection size		Connection type	Module location						Weight		Code number
			[in.]	[mm]		M1	M2	M3	M4	M5	M6	kg	lbs	
ICF SS 20	4	90	¾	20	Butt-weld DIN-EN 10220	ICFR 20A	ICFF 20	ICFA 20	ICFN 20			6.4	14.1	027L4716
ICF SS 20	6	90	¾	20	Butt-weld DIN-EN 10220	ICFS 20	ICFF 20	ICFE 20	ICFB 20	ICFR 20-A	ICFN 20	9.7	21.3	027L4713
ICF SS 20	6	90	¾	20	Butt-weld DIN-EN 10220	ICFS 20	ICFF 20	ICFE 20	ICFC 20	ICM 20-C	ICFS 20	9.7	21.3	027L4715
ICF SS 20	6	90	¾	20	Butt-weld DIN-EN 10220	ICFS 20	ICFF 20	ICFE 20	ICFC 20	ICFR 20A	ICFW 20D	8.9	17.8	027L4740
ICF SS 20	6	90	¾	20	Butt-weld DIN-EN 10220	ICFS 20	ICFF 20	ICFE 20	ICFC 20	ICFR 20B	ICFW 20D	8.9	17.8	027L4741
ICF SS 20	6	90	¾	20	Butt-weld DIN-EN 10220	ICFS 20	ICFF 20	ICFE 20H	ICFC 20	ICFR 20A	ICFW 20D	9.8	21.5	027L4748
ICF SS 20	6	90	¾	20	Butt-weld DIN-EN 10220	ICFS 20	ICFF 20	ICFE 20H	ICFC 20	ICFR 20B	ICFW 20D	9.8	21.5	027L4749
ICF SS 20	6	90	¾	20	Butt-weld DIN-EN 10220	ICFS 20	ICFF 20	ICFE 20	ICFC 20	ICFW 20D	ICFS 20	9.3	20.6	027L4768
ICF SS 20	6	90	¾	20	Butt-weld DIN-EN 10220	ICFS 20	ICFF 20	ICFE 20	ICFB 20	ICFR 20A	ICFS 20	9.9	21.8	027L3427
ICF SS 20	6	90	1	25	Butt-weld DIN-EN 10220	ICFS 20	ICFF 20E	ICFE 20H	ICFC 20	ICFR 20B	ICFW 20D	11.5	25.3	027L4723
ICF SS 20	6	90	1	25	Butt-weld DIN-EN 10220	ICFS 20	ICFF 20	ICFE 20	ICFC 20	ICFR 20A	ICFW 20D	8.9	17.8	027L4742
ICF SS 20	6	90	1	25	Butt-weld DIN-EN 10220	ICFS 20	ICFF 20	ICFE 20	ICFC 20	ICFR 20B	ICFW 20D	8.9	17.8	027L4743
ICF SS 20	6	90	1	25	Butt-weld DIN-EN 10220	ICFS 20	ICFF 20	ICFE 20H	ICFC 20	ICFR 20A	ICFW 20D	9.8	21.5	027L4750

## Valve station, Type ICF SS 20 and ICF SS 25

Type	# of modules	Appl. #	Connection size		Connection type	Module location						Weight		Code number
			[in.]	[mm]		M1	M2	M3	M4	M5	M6	kg	lbs	
ICF SS 20	6	90	1	25	Butt-weld DIN-EN 10220	ICFS 20	ICFF 20	ICFE 20H	ICFC 20	ICFR 20B	ICFW 20D	9.8	21.5	027L4751
ICF SS 20	6	90	1	25	Butt-weld DIN-EN 10220	ICFS 20	ICFF 20	ICFE 20	ICFC 20	ICFR 20D	ICFS 20	9.3	20.6	027L4767
ICF SS 20	6	90	1¼	32	Butt-weld DIN-EN 10220	ICFS 20	ICFF 20	ICFE 20	ICFC 20	ICFR 20A	ICFW 20D	8.9	17.8	027L4746
ICF SS 20	6	90	1¼	32	Butt-weld DIN-EN 10220	ICFS 20	ICFF 20	ICFE 20	ICFC 20	ICFR 20B	ICFW 20D	8.9	17.8	027L4747
ICF SS 20	6	90	1¼	32	Butt-weld DIN-EN 10220	ICFS 20	ICFF 20	ICFE 20H	ICFC 20	ICFR 20A	ICFW 20D	9.8	21.5	027L4752
ICF SS 20	6	90	1¼r	32	Butt-weld DIN-EN 10220	ICFS 20	ICFF 20	ICFE 20H	ICFC 20	ICFR 20B	ICFW 20D	9.8	21.5	027L4753
ICF SS 25	6	90	1	25	Butt-weld DIN-EN 10220	ICFS 25	ICFF 25	ICFE 25	ICFN 25	ICFR 25B	ICFW 25D	24.2	53.2	027L4189
ICF SS 25	6	90	1	25	Butt-weld DIN-EN 10220	ICFS 25	ICFF 25	ICM 25-A	ICFC 25	ICFB 25	ICFS 25	23.6	51.9	027L4763
ICF SS 25	6	90	1¼	32	Butt-weld DIN-EN 10220	ICFS 25	ICFF 25	ICM 25-B	ICFC 25	ICFB 25	ICFS 25	23.6	51.9	027L4762

### NOTE:

ICAD and coils are not included and must be ordered separately.

When used in systems with CO<sub>2</sub>, the o-rings on the ICM module can swell (grow). At service, it is therefore recommended to install new o-rings, before the ICM function module is re-installed in the ICF SS valve body. ICAD and coils are not included and must be ordered separately.

## Modules

Table 40: ICF SS with four modules

Type	Function Module Type	Can be installed in these locations			
ICFS SS	Stop valve module	M1	M2	M3	M4
ICFR SS	Manual regulating valve module	M1	M2	M3	M4
ICFF SS	Filter (strainer) module	location not possible	M2	location not possible	M4
ICFE SS	Solenoid valve module	location not possible	location not possible	M3	location not possible
ICFC SS	Check valve module	location not possible	location not possible	location not possible	M4
ICFN SS	Stop / check valve module	location not possible	location not possible	location not possible	M4
ICM SS	Motor valve module	M1	location not possible	M3	location not possible
ICFB SS	Blank top cover	M1	M2	M3	M4
ICFA SS	Electronic expansion valve module (for ICF SS 20 only)	M1	location not possible	M3	location not possible
ICFE SS 20H	Solenoid valve module (for ICF SS 20 only)	M1	location not possible	M3	location not possible
ICFO SS	Manual opening module	location not possible	location not possible	location not possible	M4
ICFW SS	Welding module	M1	M2	M3	M4

Table 41: ICF SS with six modules

Type	Function Module Type	Can be installed in these locations					
ICFS SS	Stop valve module	M1	M2	M3	M4	M5	M6
ICFR SS	Manual regulating valve module	M1	M2	M3	M4	M5	M6
ICFF SS	Filter (strainer) module	location not possible	M2	location not possible	M4	location not possible	M6
ICFE SS	Solenoid valve module	location not possible	location not possible	M3	location not possible	location not possible	location not possible
ICFC SS	Check valve module	location not possible	location not possible	location not possible	M4	location not possible	M6
ICFN SS	Stop/check valve module	location not possible	location not possible	location not possible	M4	location not possible	M6
ICM SS	Motor valve module	M1	location not possible	M3	location not possible	M5	location not possible
ICFB SS	Blank top cover	M1	M2	M3	M4	M5	M6
ICFA SS	Electronic expansion valve module (for ICF SS 20 only)	M1	location not possible	M3	location not possible	M5	location not possible

## Valve station, Type ICF SS 20 and ICF SS 25

Type	Function Module Type	Can be installed in these locations					
<b>ICFE SS 20H</b>	Solenoid valve module (for ICF SS 20 only)	M1	location not possible	M3	location not possible	M5	location not possible
<b>ICFO SS</b>	Manual opening module	location not possible	location not possible	location not possible	M4	location not possible	location not possible
<b>ICFW SS</b>	Welding module	M1	M2	M3	M4	M5	M6

**NOTE:**

Module locations are indicated by M1, M2, M3, M4, M5 and M6. With respect to refrigerant flow, M1 is closest to inlet.

## Accessories

Table 42: Accessories



Blind SS plug	Connector SS 1/2 in. - 3/8 in.	Sight glass	1/2 in. weld connector SS	Adapter SS G3/8 - 3/8 FPT
				

Table 43: Blind SS plug

Quantity	Code no.
2 pcs. 3/8" RG	<b>027L4811</b>

Table 44: Connector SS 1/2 in. - 3/8 in.

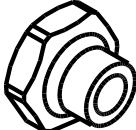
Quantity	Code no.
2	<b>027L4810</b>

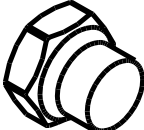
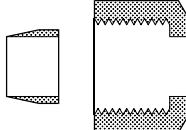
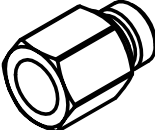
Table 45: Sight glass

Quantity	Code no.
2 pcs. 3/8" G	<b>027L4812</b>

Table 46: 1/2 in. weld connector SS

Quantity	Code no.
2	<b>148B4689</b>

Table 47: Adapter SS G3/8 - 3/8 FPT

Quantity	Code no.
2	<b>027L4813</b>

Table 48: ICAD 600A - cable, connector and protection cap

ICAD 600A	Cable	Connector	Protection cap
			

Table 49: ICAD 600A

Description	Code no.
<b>ICAD 600A</b>	With 1,5m cable <b>027H9075</b> Without cables <b>027H9120</b>
<b>Cable</b>	Cable set 10 m. <b>027H0427</b> Cable set 15 m. <b>027H0435</b>
<b>Connector</b>	Connector set female <b>027H0430</b>
<b>Protection cap</b>	Protection cap for ICAD <b>027H0431</b>

**NOTE:**

ICAD details see literature: **AI236186442940**

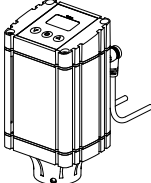
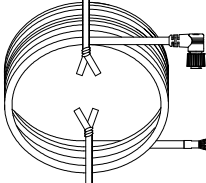
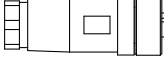
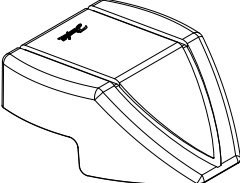
## Valve station, Type ICF SS 20 and ICF SS 25

Table 50:

SNV-SS G ½ in.	SNV-SS ¾ in.

Table 51: SNV-SS

Description	Code no.
SNV-SS for ICF SS 20/SS 25 DIN butt weld connection. Side connection: G ½ in. Bottom connection: G ½ in. Included: Adapter SS (G ½ in. - G ¾ in.)	<b>148B6545</b>
SNV SS for ICF SS 20/SS 25 DIN butt weld connection. Side connection: ¾ in. FPT Bottom connection: ¾ in. MPT Included: Adapter SS (¾ FPT - G ¾ in.)	<b>148B3750</b>

Table 52: Coils - Alternating current AC

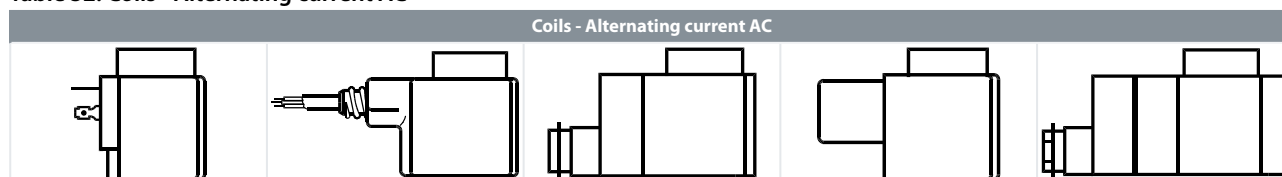

Table 53: Coils - Alternating current AC

Valve type	Voltage V	Frequency Hz	Code no.			Appendix no. *)	Power consumption
			With 1 m 3-core cable	With terminal box IP 67	With DIN plugs**)		
<b>Alternating current AC</b>							
ICFE	12	50		<b>018F6706</b>		15	Holding: 10 W 21 VA Inrush: 44 VA
	24	50	<b>018F6257</b>	<b>018F6707</b>	<b>018F7358</b>	16	
	220 – 230	50	<b>018F6251</b>	<b>018F6701</b>	<b>018F7351</b>	31	
	115	60	<b>018F6260</b>	<b>018F6710</b>		20	
<b>Direct current DC (can not be used for ICF SS 20 configurations with ICM module) Coil type I</b>							
ICFE/ICFA	12			<b>018F6856</b>		1	20 W
	24			<b>018F6857</b>		2	

Table 54: Special coils for ICFE

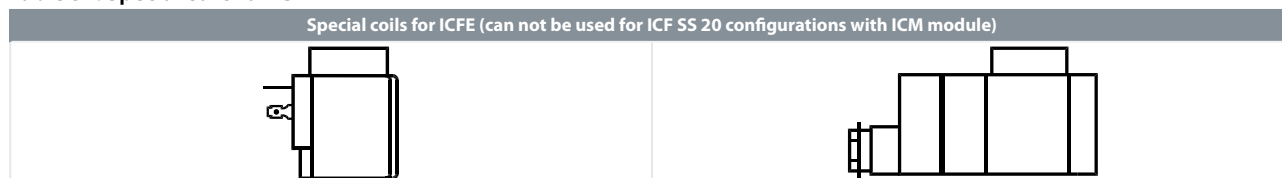

Table 55: Special coils for ICFE (can not be used for ICF SS 20 configurations with ICM module)

Valve type	Voltage V	Frequency Hz	Code no.	Appendix no. Indicates voltage and frequency	Power consumption
			With terminal box IP 67		
<b>Alternating current AC</b>					
ICFE	24	50	<b>018F6807</b>	16	Holding: 12 W 26 VA Inrush: 55 VA
	110	50	<b>018F6811</b>	22	
	220 – 230	50	<b>018F6801</b>	31	

**NOTE:**

For other coil types please refer to the technical leaflets for EVRA or AKVA valves.

**Certificates, declarations, and approvals**

The list contains all certificates, declarations, and approvals for this product type. Individual code number may have some or all of these approvals, and certain local approvals may not appear on the list.

Some approvals may change over time. You can check the most current status at danfoss.com or contact your local Danfoss representative if you have any questions.

**Table 56: Valid approvals**

Type	File name	Document type	Document topic	Approval authority
ICF SS	033F0691.AD	Manufacturers Declaration	RoHS	
	033F0686.AG	Manufacturers Declaration	PED	
	19.10325.266	Marine - Safety Certificate		RMRS
ICF 20 - 25 SS	0C18678.513467890YTN	Pressure - Safety Certificate	TSSA	CRN
	SA7200	Mechanical - Safety Certificate	UL	
ICF 20 - 25 SS Body	0C19205.2	Pressure - Safety Certificate	TSSA	CRN

**Table 57: Compliance**

ICF SS valve station		
Nominal bore	DN ≤ 25 (1 in.)	DN 32-40 (1 ¼ - 1 ½")
Classified for	Fluid group I	
Category	Article 3, paragraph 3	II

**Table 58: Compliance table ICF SS 20 and ISF SS 25**

	<b>Conformity Approvals</b> UL approved
--	--

## Online support

Danfoss offers a wide range of support along with our products, including digital product information, software, mobile apps, and expert guidance. See the possibilities below.

### The Danfoss Product Store



The Danfoss Product Store is your one-stop shop for everything product related—no matter where you are in the world or what area of the cooling industry you work in. Get quick access to essential information like product specs, code numbers, technical documentation, certifications, accessories, and more.

Start browsing at [store.danfoss.com](https://store.danfoss.com).

### Find technical documentation



Find the technical documentation you need to get your project up and running. Get direct access to our official collection of data sheets, certificates and declarations, manuals and guides, 3D models and drawings, case stories, brochures, and much more.

Start searching now at [www.danfoss.com/en/service-and-support/documentation](https://www.danfoss.com/en/service-and-support/documentation).

### Danfoss Learning



Danfoss Learning is a free online learning platform. It features courses and materials specifically designed to help engineers, installers, service technicians, and wholesalers better understand the products, applications, industry topics, and trends that will help you do your job better.

Create your Danfoss Learning account for free at [www.danfoss.com/en/service-and-support/learning](https://www.danfoss.com/en/service-and-support/learning).

### Get local information and support



Local Danfoss websites are the main sources for help and information about our company and products. Find product availability, get the latest regional news, or connect with a nearby expert—all in your own language.

Find your local Danfoss website here: [www.danfoss.com/en/choose-region](https://www.danfoss.com/en/choose-region).

### Spare Parts



Get access to the Danfoss spare parts and service kit catalog right from your smartphone. The app contains a wide range of components for air conditioning and refrigeration applications, such as valves, strainers, pressure switches, and sensors.

Download the Spare Parts app for free at [www.danfoss.com/en/service-and-support/downloads](https://www.danfoss.com/en/service-and-support/downloads).

### Coolselector®2 - find the best components for you HVAC/R system



Coolselector®2 makes it easy for engineers, consultants, and designers to find and order the best components for refrigeration and air conditioning systems. Run calculations based on your operating conditions and then choose the best setup for your system design.

Download Coolselector®2 for free at [coolselector.danfoss.com](https://coolselector.danfoss.com).

Danfoss can accept no responsibility for possible errors in catalogues, brochures and other printed material. Danfoss reserves the right to alter its products without notice. This also applies to products already on order provided that such alterations can be made without subsequential changes being necessary in specifications already agreed. All trademarks in this material are property of the respective companies. Danfoss and the Danfoss logotype are trademarks of Danfoss A/S. All rights reserved.