

Operating Guide

# RAVI

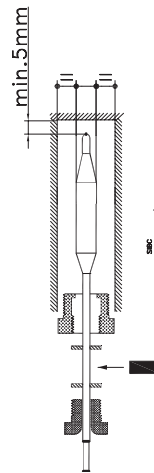
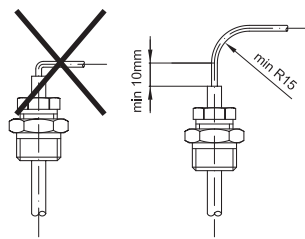
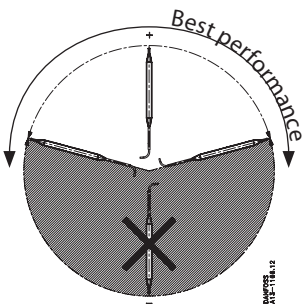
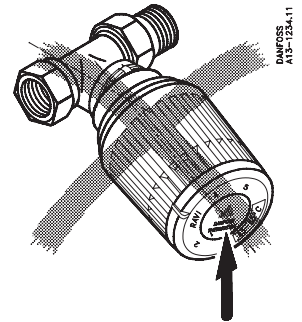
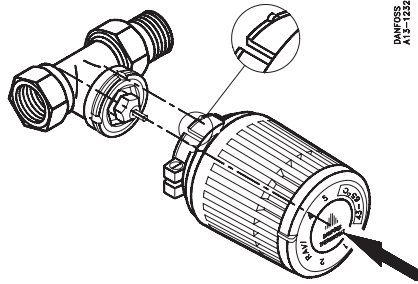
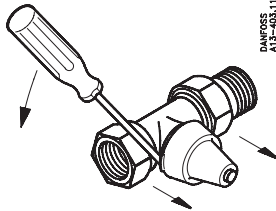
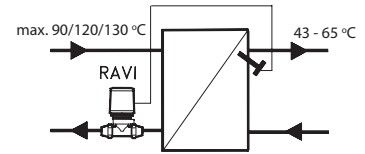
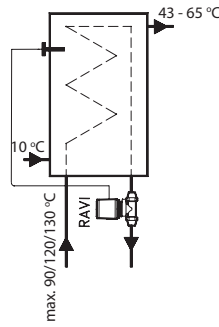
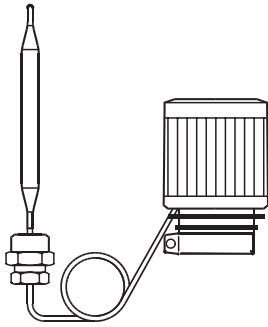

Fig. A

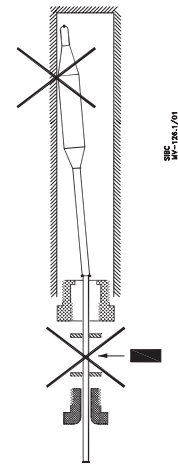

Fig. B

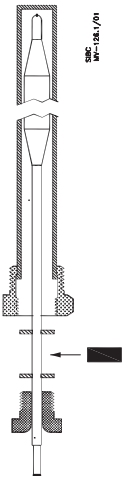

Fig. C

- Install sensor part as shown on **figure A** in order to assure at least 5 mm distance between sensor housing made of brass and other metal parts.
- Consider adequate distance over the whole side length and end part of the sensor (**fig. A**).
- Assure that sensor is properly fixed; larger dimension of capillary tube has to be fixed with stuffing box (2 washers with rubber gasket in between, tightened with screw), (**fig. A**).

- By installation shown on **figure A** you also assure the optimal arm (distance between stuffing box where sensor is fixed and end part of the sensors inserted in the media in heat exchanger or boiler) which will reduce the risk of vibrations which could cause a metal contact.
- Please avoid installation which is shown on **figure B** (thinner diameter of capillary tube fits in stuffing box, longer arm etc.).

- If you can not avoid or at least you assume the possibility of metal contact, than you have to use a protecting pocket (sleeve) made of stainless steel (**figure C**).

By using this standard type of accessory you will be faced with longer response time of RAV's performance due to Crte slower heat transition.

RAVI

Setting

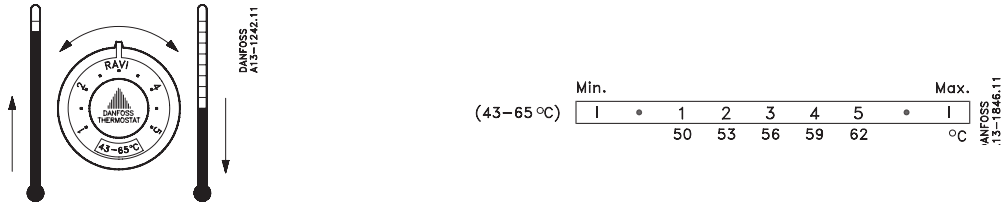

Limiting or locking of setting range

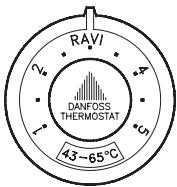
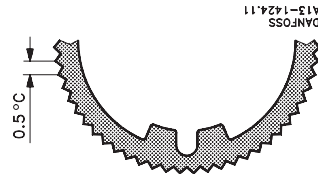
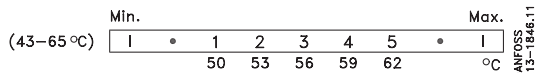

DANFOSS  
A13-1421.12

1a

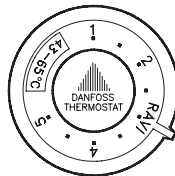

DANFOSS  
A13-1422.12

2a

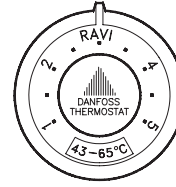

DANFOSS  
A13-1423.12

3a

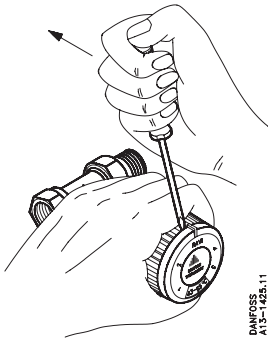

DANFOSS  
A13-1425.11

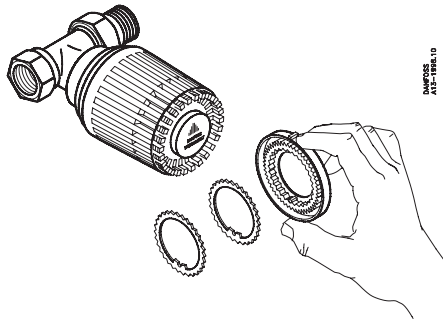

DANFOSS  
A13-1426.10

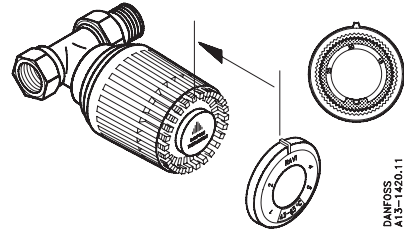

DANFOSS  
A13-1420.11

1b/2b/3b

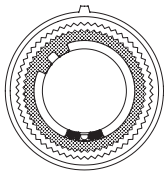

DANFOSS  
A13-1426.12

1c

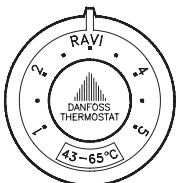

DANFOSS  
A13-1394.10

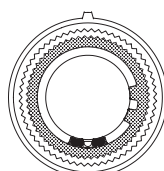

DANFOSS  
A13-1427.12

2c

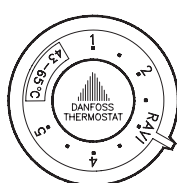

DANFOSS  
A13-1430.11

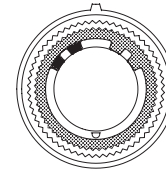

DANFOSS  
A13-1428.12

3c

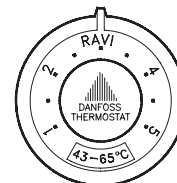

DANFOSS  
A13-1394.10

Danfoss can accept no responsibility for possible errors in catalogues, brochures and other printed material. Danfoss reserves the right to alter its products without notice. This also applies to products already on order provided that such alterations can be made without subsequential changes being necessary in specifications already agreed. All trademarks in this material are property of the respective companies. Danfoss and the Danfoss logotype are trademarks of Danfoss A/S. All rights reserved.