



Data sheet

Differential pressure controller with flow limitation (PN 16, 25, 40) AFPB 2 / VFQ 22(1) – return mounting, adjustable setting AFPB-F 2 / VFQ 22(1) – return mounting, fixed setting

Description



virtus.danfoss.com



The controller is a self-acting differential pressure controller with flow limitation primarily for use in district heating systems. The controller closes on rising differential pressure or when set max. flow is exceeded.

The controller has a control valve with adjustable flow restrictor, an actuator with one control diaphragm and spring for differential pressure setting.

- Further on two valve versions are available:
- VFQ 22 with metallic sealing cone
 - VFQ 221 with soft sealing cone

Together with Danfoss intelligent electrical actuator AMEi 6 intelligent optimization functions are available:

- iSET-intelligent substation efficiency optimization
- iNET-intelligent network balancing

Main data:

- DN 65-250
- k_{vs} 60-800 m³/h
- Flow range 5.6-500 m³/h
- PN 16, 25, 40
- Setting range: 0.1-1 bar / 0.5-1.5 bar
- Temperature: – Circulation water / glycolic water up to 30%: 2 ... 150°C
- Connections: Flange

Ordering

Example 1:
Differential pressure controller with flow limitation return mounting, DN 65, k_{vs} 60, PN 16, metallic sealing, setting range 0.5-1.5 bar, T_{max} 150 °C, flange

- 1x VFQ 22 DN 65 valve
Code no: .
- 1x AFPB 2 actuator
Code no: . .
- 1x AFPB 2 DN65 impulse tubes
Code no: . .
- 1x Impulse tube set AF
Code no: . .

Products will be delivered separately.

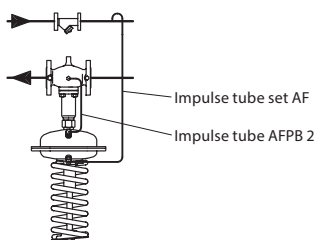

VFQ 22 Valve (metallic sealing cone)

Picture	DN (mm)	k_{vs} (m ³ /h)	Connections	T_{max} (°C)	Code No.		
					PN 16	PN 25	PN 40
	65	60	Flanges acc. to EN 1092-1	150	065B5570	065B5577	065B5584
	80	80			065B5571	065B5578	065B5585
	100	160			065B5572	065B5579	065B5586
	125	250			065B5573	065B5580	065B5587
	150	380			065B5574	065B5581	065B5588
	200	650			065B5575	065B5582	065B5589
	250	800	065B5576	065B5583	065B5590		

VFQ 221 Valve (soft sealing cone)

Picture	DN (mm)	k_{vs} (m ³ /h)	Connections	T_{max} (°C)	Code No.		
					PN 16	PN 25	PN 40
	65	60	Flanges acc. to EN 1092-1	150	065B5600	065B5607	065B5614
	80	80			065B5601	065B5608	065B5615
	100	160			065B5602	065B5609	065B5616
	125	250			065B5603	065B5610	065B5617
	150	380			065B5604	065B5611	065B5618
	200	650			065B5605	065B5612	065B5619
					065B5606	065B5613	065B5620
	250	800					

Ordering (continuous)

AFPB 2 / AFPB-F 2 Actuators

Picture	Δp setting range (bar)	Possible combinations with DN							Actuator size (cm ²)	Spring colour	Code No.	
		65	80	100	125	150	200	250			PN16	PN40
	0.5-1.5	✓	✓	✓	✓	-	-	-	160	yellow	003G5608	003G5618
	0.4-1.5	✓	✓	✓	✓	✓	✓	✓	320	red	003G5609	003G5619
	0.1-1	✓	✓	✓	✓	-	-	-	160	blue	003G5612	003G5622
	0.1-1	✓	✓	✓	✓	✓	✓	✓	320	orange	003G5610	003G5620
	0.2	✓	✓	✓	✓	-	-	-	160	-	003G5600	003G5602
	0.5	✓	✓	✓	✓	-	-	-	160	-	003G5601	003G5603
	0.2	✓	✓	✓	✓	✓	✓	✓	320	-	003G5596	003G5598
	0.5	✓	✓	✓	✓	✓	✓	✓	320	-	003G5597	003G5599

Impulse tubes

Picture AFPB-F(2)	Actuator size (cm ²)	Valve (DN)	Code No.
	160	65	003G1842
		80	003G1856
		100	003G1857
		125	003G1858
	320	150	003G1859
		200	003G1860
		250	003G1861



Accessories

Picture	Type designation	Description	Connections	Code No.
	Impulse tube set AF	- 1x Copper tube Ø10 x 1 x 1500 mm - 1x compression fitting for imp. tube connection to pipe (G ¼) - 2x socket	-	003G1391
	Compression fitting ¹⁾	For impulse tube Ø10 connections to controller	G¼	003G1468
	Shut off valve	For impulse tube Ø10	-	003G1401
	Static throttle valve			065B2909
	Dynamic throttle valve ²⁾	For impulse tube Ø10 / connection to pressure actuator	G¼	003G1771
	Adapter	new AFP 2-old VFG	DN 15-250	003G1780
	AMEi 6 iSET el. actuator 230 V	Intelligent Δp actuator with iSET function		082G4300
	AMEi 6 iSET el. actuator 24 V			082G4301
	AMEi 6 iNET el. actuator 230 V	Intelligent Δp actuator with iNET function		082G4302
	AMEi 6 iNET el. actuator 24 V			082G4303

¹⁾ Consist of a nipple, compression ring and nut

²⁾ Available in 2022

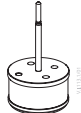
Service kits

Picture	Type	k_{vs} (m ³ /h)	PN	DN	Code No.
	Pressure control insert VFG/Q 22	60	16/25/40	65	003G1800
		80		80	003G1801
		160		100	003G1802
		250		125	003G1803
		380		150	003G1804
		650		200	003G1805
		800		250	003G1806
	Pressure control insert VFG/Q 221	60		65	003G1807
		80		80	003G1808
		160		100	003G1809
		250		125	003G1810
		380		150	003G1811
		650		200	003G1812
		800		250	003G1813
	Pressure stuffing box VFG/Q 221			65-125	003G1730
				150-250	003G1731

Installation position

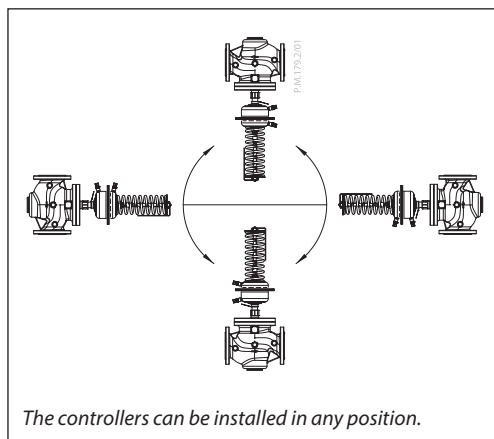

Technical data

VFQ 22(1) Valve

Nominal diameter				DN	65	80	100	125	150	200	250	
k _{VS} value of Δp controller				m ³ /h	60	80	160	250	380	650	800	
Range of max. flow setting	Δp _{SP}	Δp _{SYSTEM}	Δp _b									
	0.2	0.1	0.1	to	19	25	51	79	120	206	253	
	0.5	0.3	0.2	to	28	40	63	100	160	270	360	
	1.0	0.5	0.5	to	42	60	95	150	240	340	500	
Cavitation factor z					0.65	0.55	0.4	0.4	0.4	0.35	0.3	
Leakage acc. to standard IEC 534 (% of k _{VS})				VFQ 22	≤ 0.03				≤ 0.05			
				VFQ 221	≤ 0.01							
Nominal pressure				PN	16, 25, 40							
Min. differential pressure					see remark ²⁾							
Max. differential pressure PN 16				bar	16		15	15	12	10	10	
Max. differential pressure PN 25/40					20							
Pressure reliefment system				Chamber relieved								
Media				Circulation water / Glycolic water up to 30 %								
Media pH				Min.7, max.10								
Media temperature				°C	2 ... 150							
Connections				Flange								
Materials												
Valve body				PN 16	Grey cast iron EN-GJL-250 (GG-25)							
				PN 25	Ductile iron EN-GJS-400(GGG-40.3)							
				PN 40	Cast steel GP240GH (GS-C 25)							
Valve seat / Valve cone				Stainless steel, mat. No. 1.4021								
Sealing				EPDM								

¹⁾ Max. flow rate depends on the differential pressure over the system (dp System). System is part of the application where differential pressure is controlled by AFPB(-F) and for this part the resistance is well known/defined.
Flow rates in table are specified for 3 different situations.

$$\Delta p_{SP} = \Delta p_{SYSTEM} + \Delta p_b$$

Δp_{SP} - differential pressure set point
Δp_{SYSTEM} - system differential pressure
Δp_b - differential pressure over flow restrictor

²⁾ Depends on the flow rate and valve k_{VS}; For Q_{set} = Q_{max} → Δp_{min} ≥ 0.5 bar; For Q_{set} < Q_{max} → Δp_{min} = $\left(\frac{Q}{k_{VS}}\right)^2 + \Delta p_b$

AFPB(-F) 2 Actuator

Type		AFPB 2				AFPB-F 2	
Actuator size	cm ²	160		320		160	320
Max. operating pressure	bar	16, 40					
Diff. pressure setting ranges and spring colour		0.1-1	0.5-1.5	0.1-1	0.4-1.5	0.2/0.5	
		blue	yellow	orange	red	-	-
For valve DN		65-125	65-125	65-250		65-125	65-250
Materials							
Actuator housing		Steel, mat. No. 1.0345, zinc plated					
Control diaphragm		EPDM (Rolling; fibre enforced)					

Operating area

Maximum allowed differential pressure over the controller (Δp_{max}) at different cavitation factors (z)

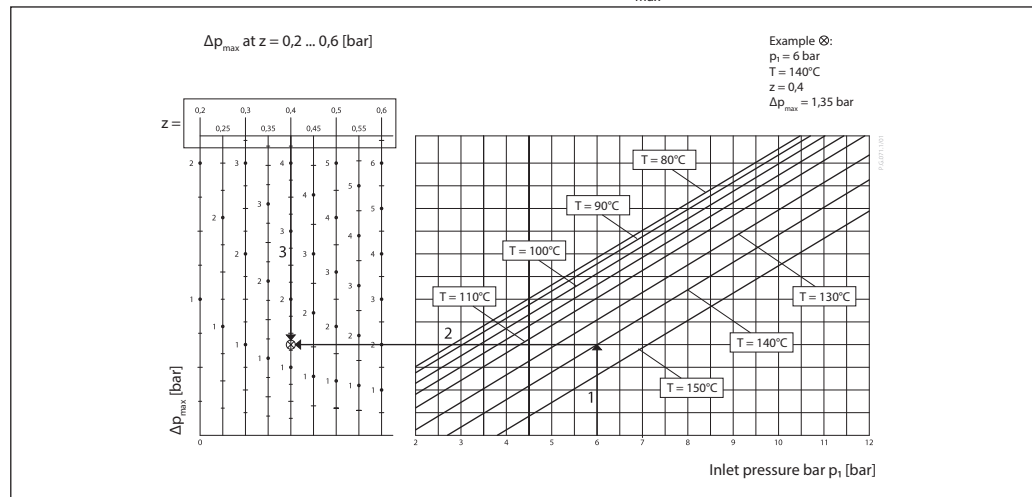

Application principles
– Return mounting

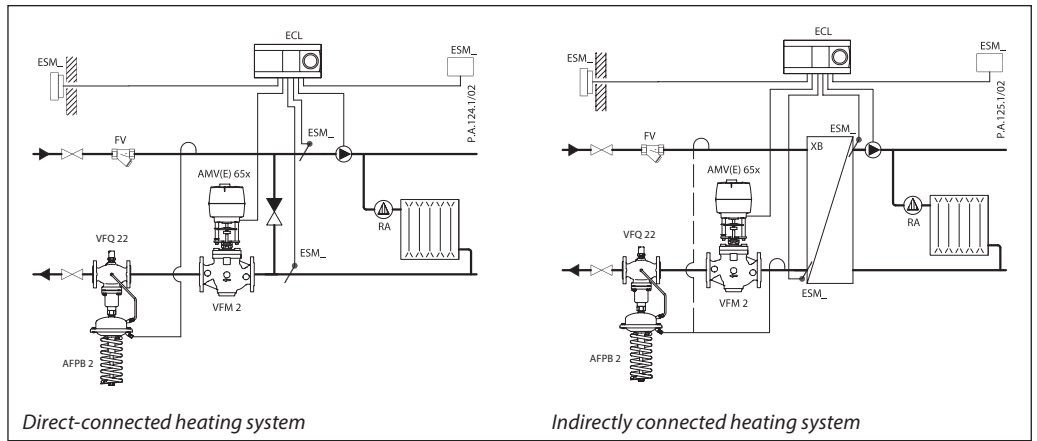

Pressure temperature diagram

Working area is below P-T line and it ends at T_{max} for each valve

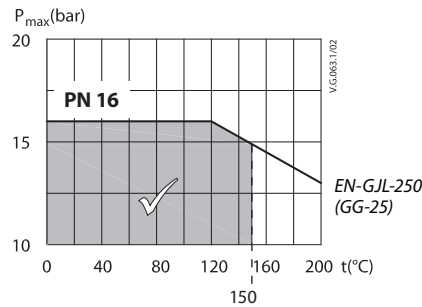

Maximum allowed operating pressure as a function of media temperature (according to EN 1092-2)

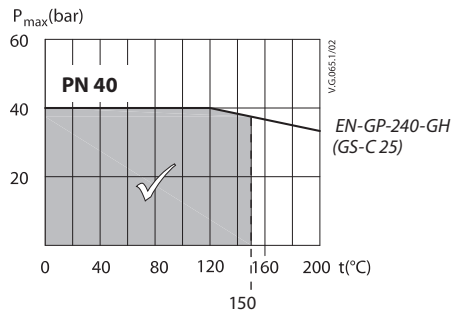
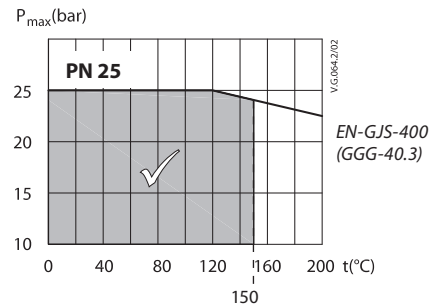

Maximum allowed operating pressure as a function of media temperature (according to EN 1092-1)

Sizing

- Directly connected heating system

Example 1

Motorised control valve (MCV) for mixing circuit in direct-connected heating system requires differential pressure of 0.3 bar (30 kPa) and flow less than 25.000 l/h.

Given data:

- $Q_{max} = 25 \text{ m}^3/\text{h}$ (25.000 l/h)
- $\Delta p_{min} = 0.7 \text{ bar}$ (70 kPa)
- $\Delta p_{circuit}^{1)} = 0.1 \text{ bar}$ (10 kPa)
- $\Delta p_{MCV} = 0.3 \text{ bar}$ (30 kPa) selected
- $\Delta p_b^{2)} = 0.1 \text{ bar}$ (10 kPa) assumption

Remark:

- ¹⁾ $\Delta p_{circuit}$ corresponds to the required pump pressure in the heating circuit and is not to be considered when sizing the AFPB.
- ²⁾ Δp_b is differential pressure over flow restrictor.

is differential pressure over flow restrictor.

$$\Delta p_{set\ value} = \Delta p_b - \Delta p_{MCV} = 0.1 - 0.3$$

$$\Delta p_{set\ value} = 0.4 \text{ bar} \text{ (40 kPa)}$$

The total pressure loss across the controller is:

$$\Delta p_{AFPB} = \Delta p_{min} - \Delta p_{MCV} = 0.7 - 0.3$$

$$\Delta p_{AFPB} = 0.4 \text{ bar} \text{ (40 kPa)}$$

The total pressure loss across the controller is:

$$\Delta p_{AFPB} = \Delta p_{min} - \Delta p_{MCV} = 0.7 - 0.3$$

$$\Delta p_{AFPB} = 0.4 \text{ bar} \text{ (40 kPa)}$$

Possible pipe pressure losses in tubes, shut-off fittings, heatmeters, etc. are not included.

k_v value is calculated according to formula:

$$k_v = \frac{Q_{max}}{\sqrt{\Delta p_{AFPB} - \Delta p_b}} = \frac{25}{\sqrt{0.4 - 0.1}}$$

$$k_v = 45.6 \text{ m}^3/\text{h}$$

Solution:

The example selects AFPB 2/VFQ 22 DN 80; k_{vS} value 80 m^3/h ; with differential pressure setting range 0.1-1 bar; maximum flow 25 m^3/h .

If other differential pressure is assumed than $\Delta p_b = 0.1 \text{ bar}$, in order to maintain the k_{vS} value, the flow has to be adjusted using the flow restrictor screw. The new set value (Q-setting) of the assumed differential pressure ($\Delta p_{b\ NEW} = 0.2 \text{ bar}$) is calculated according to formula:

$$Q_{setting} = \frac{\sqrt{\Delta p_b}}{\sqrt{\Delta p_{b\ NEW}}} \times Q_{max}$$

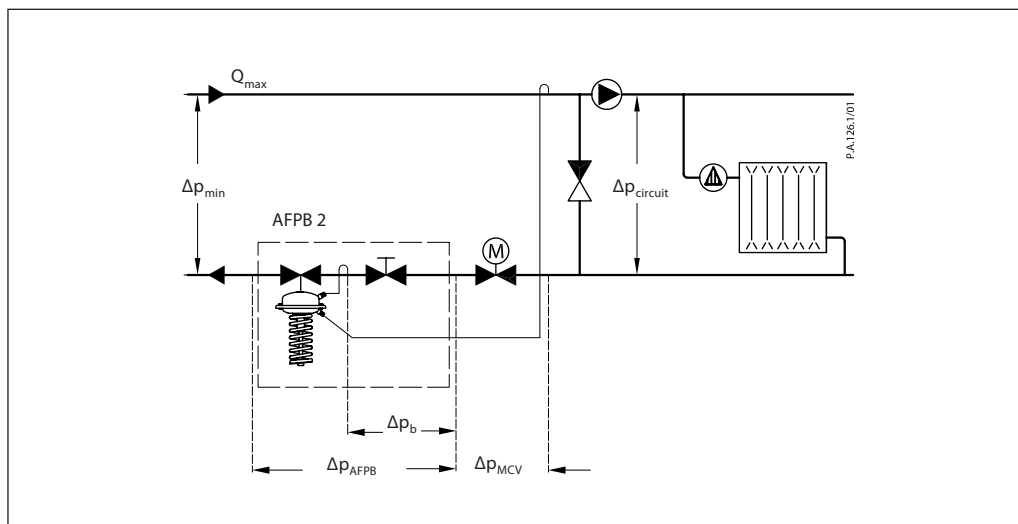

Sizing (continuous)

- Indirectly connected heating system

Example 2

Motorised control valve (MCV) for indirectly connected heating system requires differential pressure of 0.5 (50 kPa) bar and flow less than 24.000 l/h.

Given data:

- $Q_{max} = 24 \text{ m}^3/\text{h}$ (24.000 l/h)
- $\Delta p_{min} = 1 \text{ bar}$ (100 kPa)
- $\Delta p_{exchanger} = 0.1 \text{ bar}$ (10 kPa)
- $\Delta p_{MCV} = 0.5 \text{ bar}$ (50 kPa) selected
- $\Delta p_b^{1)} = 0.2 \text{ bar}$ (20 kPa)

Remark:

¹⁾ Δp_b is differential pressure over flow restrictor

The differential pressure set value is:

$$\Delta p_{set \text{ value}} = \Delta p_b + \Delta p_{exchanger} + \Delta p_{MCV} = 0.2 + 0.1 + 0.5$$

$$\Delta p_{set \text{ value}} = 0.8 \text{ bar} \text{ (80 kPa)}$$

The total pressure loss across the controller is:

$$\Delta p_{AFPB} = \Delta p_{min} - \Delta p_{exchanger} - \Delta p_{MCV} = 1 - 0.1 - 0.5$$

$$\Delta p_{AFPB} = 0.4 \text{ bar} \text{ (40 kPa)}$$

Possible pipe pressure losses in tubes, shut-off fittings, heatmeters, etc. are not included.

k_v value is calculated according to formula:

$$k_v = \frac{Q_{max}}{\sqrt{\Delta p_{AFPB} - \Delta p_b}} = \frac{24}{\sqrt{0.4 - 0.2}}$$

$$k_v = 53.7 \text{ m}^3/\text{h}$$

Solution:

The example selects AFPB 2/VFQ 22 DN 65; k_{vS} value 60 m^3/h ; with differential pressure setting range 0.1-1 bar; maximum flow 28 m^3/h . If other differential pressure is assumed than $\Delta p_b = 0.1 \text{ bar}$, in order to maintain the k_{vS} value, the flow has to be adjusted using the flow restrictor screw. The new set value (Q-setting) of the assumed differential pressure ($\Delta p_{b \text{ NEW}} = 0.2 \text{ bar}$) is calculated according to formula:

$$Q_{setting} = \frac{\sqrt{\Delta p_b}}{\sqrt{\Delta p_{b \text{ NEW}}}} \times Q_{max}$$

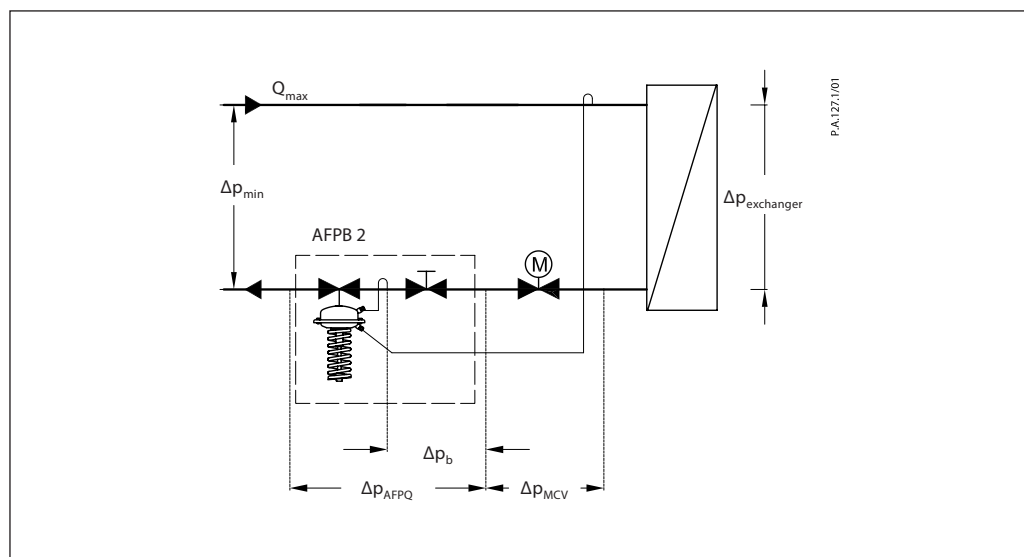

Design

- 1. Valve body
- 2. Cover
- 3. Adjustable flow restrictor
- 4. Valve seat
- 5. Valve insert
- 6. Pressure relieved valve cone
- 7. Valve stem
- 8. Actuator
- 9. Control diaphragm for differential pressure and flow control
- 10. Excess pressure safety valve
- 11. Built in spring for differential pressure and flow control
- 12. Setting spring for diff. pressure control
- 13. Adjuster for diff. pressure setting, prepared for sealing
- 14. Stuffing cone
- 15. Union nut
- 16. Impulse tube
- 17. Compression fitting for impulse tube
- 18. Upper casing of diaphragm
- 19. Lower casing of diaphragm

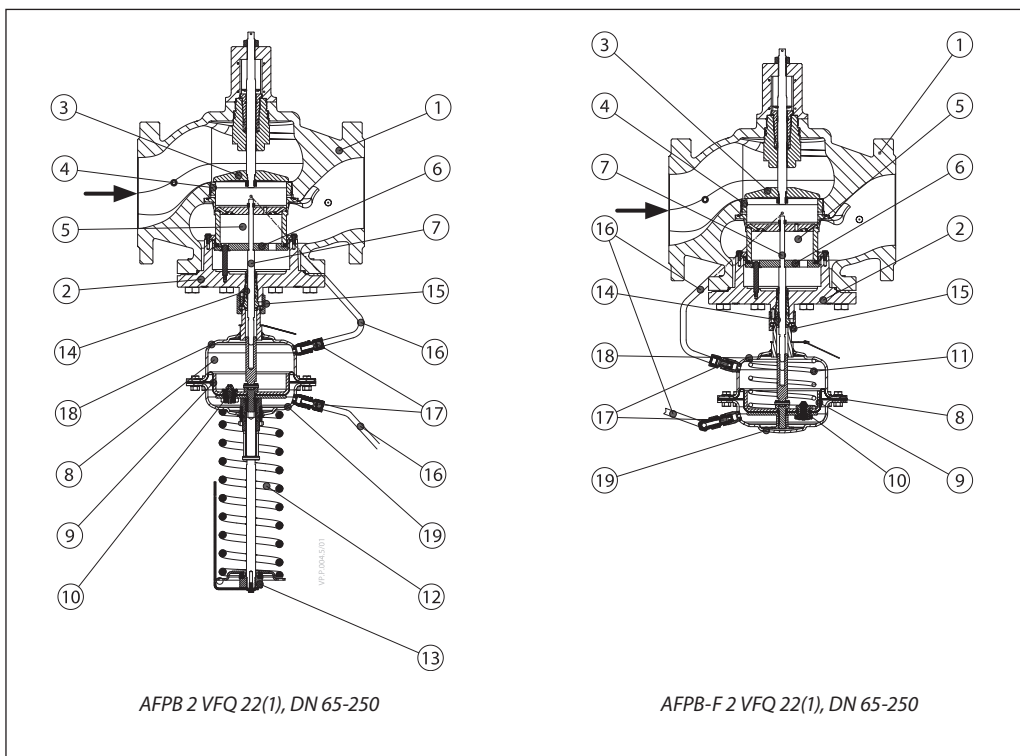

Function

Pressure changes from flow and return pipes are being transferred through the impulse tubes to the actuator chambers and act on control diaphragm for diff. pressure and flow control. The diff. pressure is controlled by means of setting spring for diff. pressure control. Control valve closes on rising differential pressure and opens on falling differential pressure to maintain constant differential pressure. Flow volume is limited by means of the flow restrictor.

Controller is equipped with excess pressure safety valve, which protects control diaphragm for diff. pressure and flow control from too high differential pressure.

Settings

Differential pressure setting
 Differential pressure setting is being done by the adjustment of the setting spring for diff. pressure control. This is done by rotating the differential pressure setting nut. Set differential pressure should be checked by observing the pressure indicators.

Flow setting
 Flow setting is being done by the adjustment of the flow restrictor position. The adjustment can be performed on the basis of flow adjustment diagram (see relevant instructions) and/or by the means of heat meter.

Dimensions

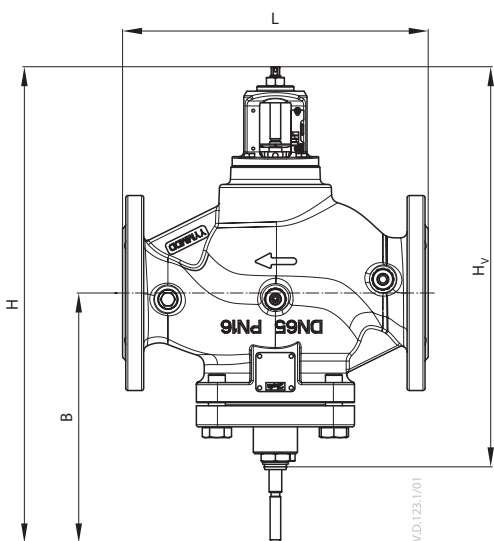

VFQ 22(1) DN 65-250

VFQ 22, VFQ 221 Valves

DN	L	B	H	H _V	Weight		
					PN 16	PN 25	PN 40
					kg		
65	290	237	473	396	28	29	31
80	310	237	473	396	33	34	36
100	350	272	547	472	52	53	57
125	400	268	582	514	71	72	79
150	480	326	670	610	123	126	135
200	600	361	773	713	230	236	286
250	730	419	843	783	382	392	441

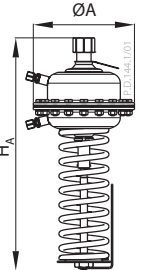

AFPB 2 Actuator

Size (cm ²)	ØA mm	H _A mm	H _{Ai} mm	Weight (kg)			
				AFPB 2 PN 16		AFPB 2 PN 40	
				+	AMEi 6	+	AMEi 6
160	230	490	590	12,5	15	25	27,5
320	300	490	590	17	19,5	37	39,5

Total installation height of the controller (VFQ 22(1) valve + AFP 2 pressure actuator) is sum of H_V and H_A (H_{Ai})

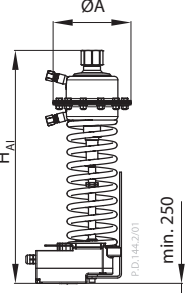

AMEi 6 intelligent actuator with iSET/ iNET functionality should be ordered separately

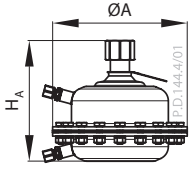

AFPB-F 2 Actuator

Size cm ²	ØA mm	H _A mm	Weight	
			PN 16	PN 40
			kg	
160	230	200	8	10
320	300	200	13	19

Total installation height of the controller (VFQ 22(1) valve + AFPB-F 2 pressure actuator) is sum of H_V and H_A

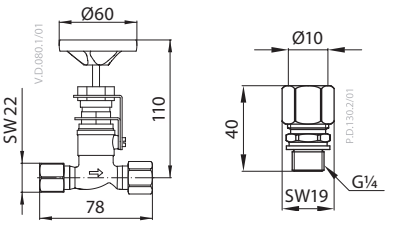

Shut off valve Compression fitting

Danfoss A/S

Climate Solutions • danfoss.com • +45 7488 2222

All information, including, but not limited to information on selection of product, its application or use, product design, weight, dimensions, capacity or any other technical data in product manuals, catalogues descriptions, advertisements, etc. and whether made available in writing, orally, electronically, online or via download, shall be considered informative, and is only binding if and to the extent, explicit reference is made in a quotation or order confirmation. Danfoss cannot accept any responsibility for possible errors in catalogues, brochures, videos and other material. Danfoss reserves the right to alter its products without notice. This also applies to products ordered but not delivered provided that such alterations can be made without changes to form, fit or function of the product.

All trademarks in this material are property of Danfoss A/S or Danfoss group companies. Danfoss and the Danfoss logo are trademarks of Danfoss A/S. All rights reserved.