

Data sheet

Pressure independent control valve with integrated flow limiter AFQM 2 - return and flow mounting

Description



virtus.danfoss.com



AFQM 2 is a self-acting flow controller with integrated control valve developed for the use in district heating / cooling systems. The controller prevents flow to exceed set max flow. In a combination with electrical actuators AMV(E) and ECL electronic controllers the flow and temperature can be controlled to achieve highest energy savings.

AFQM 2 has a control valve with adjustable flow limiter, connection neck for electrical actuator and a pressure actuator with one control diaphragm. Controllers are used together with Danfoss electrical actuators:

- AFQM 2 DN 65-250
 - AMV(E) 655 without spring return function and with manual operation;
 - AMV(E) 658 SD²⁾ spring return function and manual operation;
 - AMV(E) 659 SD¹⁾ spring return function;
 - AMV(E) 55

- AFQM 2 DN 65-125
 - AMV(E) 56

¹⁾ DIN approved (according to EN 14597)

²⁾ not DIN approved

Main data:

- DN 65-250
- k_{vs} 60-800 m³/h
- Flow range 5.6-500 m³/h
- PN 16, 25, 40
- Differential pressure over the flow control cone Δp_{cv} :
 - 0.2 bar (standard version) or
 - 0.5 bar (high flow version)
- Temperature:
 - Circulation water / glycolic water up to 30 %: 2 ... 150°C
- Connections: Flange

Ordering

Example:
Flow controller with integrated control valve for flow rate, DN 65, k_{vs} 60, PN 16, flow restrictor Δp_{cv} 0.2 bar, T_{max} 150 °C, flange

- 1x AFQM 2 DN 65 controller
Code No.: **003G5500**

The controller will be delivered completely assembled, inclusive impulse tubes between valve and actuator. Electrical actuator AMV(E) must be ordered separately.

AFQM 2 Controller

Picture	DN	Q_{max}		PN	Connection	Code No.	
		$\Delta p_{cv}=0.2$ bar	$\Delta p_{cv}=0.5$ bar			$\Delta p_{cv}=0.2$ bar	$\Delta p_{cv}=0.5$ bar
	65	28	42	16	Flange EN 1092-1	003G5500	003G5501
	80	40	60			003G5502	003G5503
	100	63	95			003G5504	003G5505
	125	100	150			003G5506	003G5507
	150	160	240			003G5508	003G5509
	200	270	340			003G5510	003G5511
	250	360	500			003G5512	003G5513
	65	28	42	25		003G5514	003G5515
	80	40	60			003G5516	003G5517
	100	63	95			003G5518	003G5519
	125	100	150			003G5520	003G5521
	150	160	240			003G5522	003G5523
	200	270	340			003G5524	003G5525
	250	360	500			003G5526	003G5527
	65	28	42	40		003G5528	003G5529
	80	40	60			003G5530	003G5531
	100	63	95			003G5532	003G5533
	125	100	150			003G5534	003G5535
	150	160	240			003G5536	003G5537
	200	270	340			003G5538	003G5539
	250	360	500			003G5540	003G5541

Service kits

Picture	Type	k_{vs} (m³/h)	PN	DN	Code No.
	Pressure control insert VFG/Q 221	60	16/25/40	65	003G1807
		80		80	003G1808
		160		100	003G1809
		250		125	003G1810
		380		150	003G1811
		650		200	003G1812
		800		250	003G1813
	Flow stuffing box VFG/Q 22(1)			65-125	003G1720
				150-250	003G1721
	Pressure stuffing box VFG/Q 22(1)			65-125	003G1730
				150-250	003G1731

Picture	Type	PN	Δp_{cv} (bar)	Actuator size (cm²)	Code no.
	Pressure actuator	16	0.2	160	003G5600
			0.5		003G5601
			0.2	320	003G5596
			0.5		003G5597
		40	0.2	160	003G5602
			0.5		003G5603
			0.2	320	003G5598
			0.5		003G5599

Technical data

AFQM 2 valve

Nominal diameter		DN	65	80	100	125	150	200	250	
k _{VS} value		m ³ /h	60	80	160	250	380	650	800	
Range of max. flow setting	Δp _{CV} ¹⁾ = 0.2 bar	Q _{min}	5.6	8.0	12.6	20	32	54	72	
		Q _{max}	28	40	63	100	160	270	360	
	Δp _{AFQM} ¹⁾		bar	0.45		0.4		0.45		
	Δp _{CV} ¹⁾ = 0.5 bar	Q _{min}	8.4	12	19	30	48	68	100	
Q _{max}		42	60	95	150	240	340	500		
Δp _{AFQM} ¹⁾		bar	1.0		0.9		0.8			
Stroke		mm	12	19	23	28	32			
Control valve authority		1 (100 %) in the range of flow setting								
Control characteristic		split								
Cavitation factor z			0.65	0.55	0.4	0.4	0.4	0.4	0.3	
Leakage acc. to standard IEC 534		% of k _{VS}	≤ 0.01							
Nominal pressure		PN	16, 25, 40							
Min. differential pressure			see remark ²⁾							
Max. differential pressure PN 16		bar	16	16	15	15	12	10	10	
Max. differential pressure PN 25/40			20	20						
Pressure relievement system		Chamber relieved								
Media		Circulation water / Glycolic water up to 30 %								
Media pH		Min.7, max.10								
Media temperature		°C	2 ... 150							
Connections		Flange								
Materials										
Valve body		PN 16	Grey cast iron EN-GJL-250 (GG-25)							
		PN 25	Ductile iron EN-GJS-400-18-LT (GGG-40.3)							
		PN 40	Cast steel GP240GH (GS-C 25)							
Valve seat DP, CV		Stainless steel, mat. No. 1.4021								
Valve cone DP, CV		Stainless steel, mat. No. 1.4021								
Sealing DP, CV		EPDM								

¹⁾ DP-diff. pressure over the pressure control cone, CV-diff. pressure over the flow control cone, Δp_{AFQM} - diff. pressure required for Q_{max}

²⁾ For flows smaller than Q_{max} -> Δp_{AFQM} = $\left(\frac{Q}{k_{VS}}\right)^2 + \Delta p_{CV}$

AFQM 2 actuator

For valve		DN	65	80	100	125	150	200	250	
Actuator size		cm ²	160				320			
Max. operational pressure		bar	16 or 40							
Differential pressure over the flow control cone Δp _{CV}			0.2 or 0.5							
Materials										
Housing		Steel, mat. No. 1.0345, zinc plated								
Diaphragm		EPDM (Rolling; fibre enforced)								
Impulse tube		Stainless steel tube Ø10 × 0.8 mm								

Operating area

Maximum allowed differential pressure over the controller (Δp_{max}) at different cavitation factors (z)

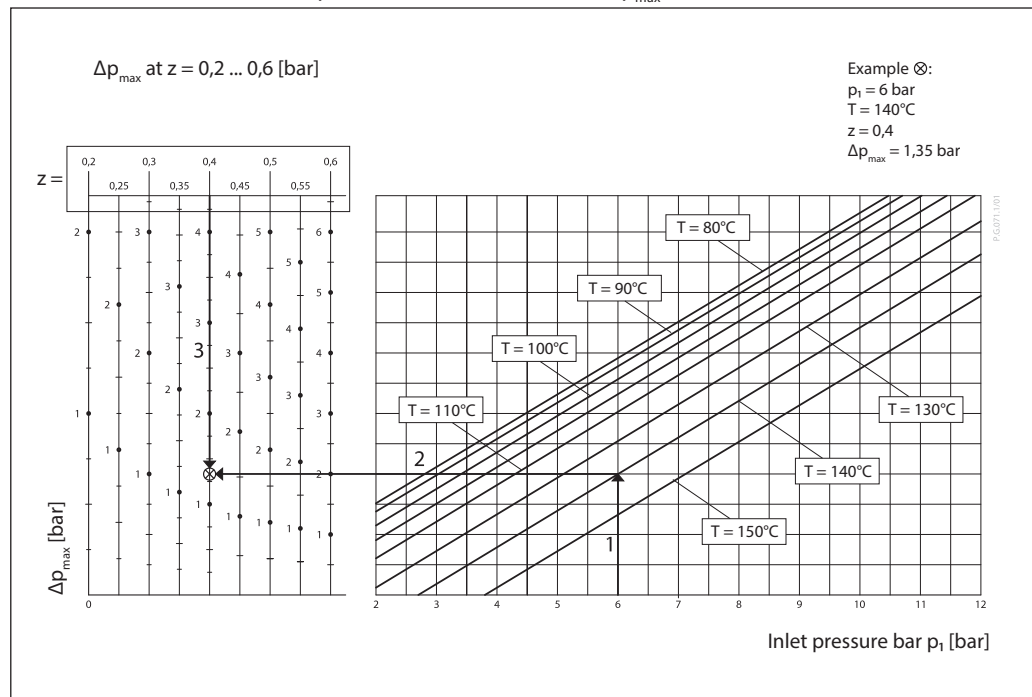

Application principles
- Return mounting

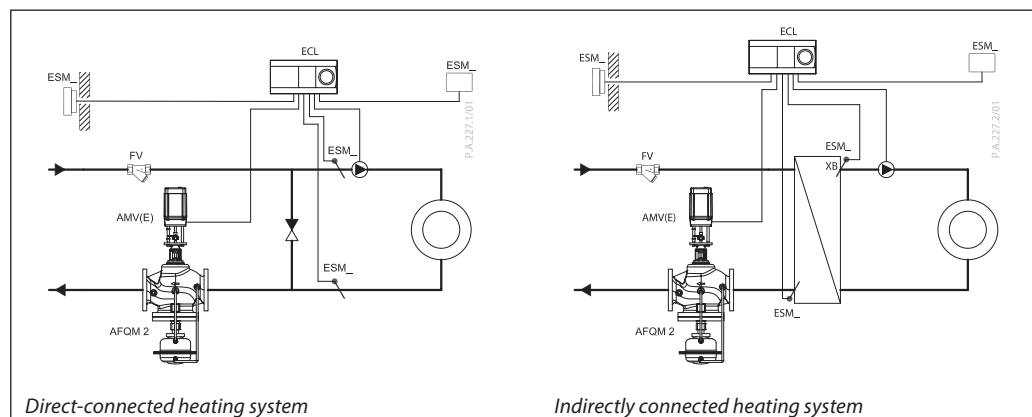

- Flow mounting

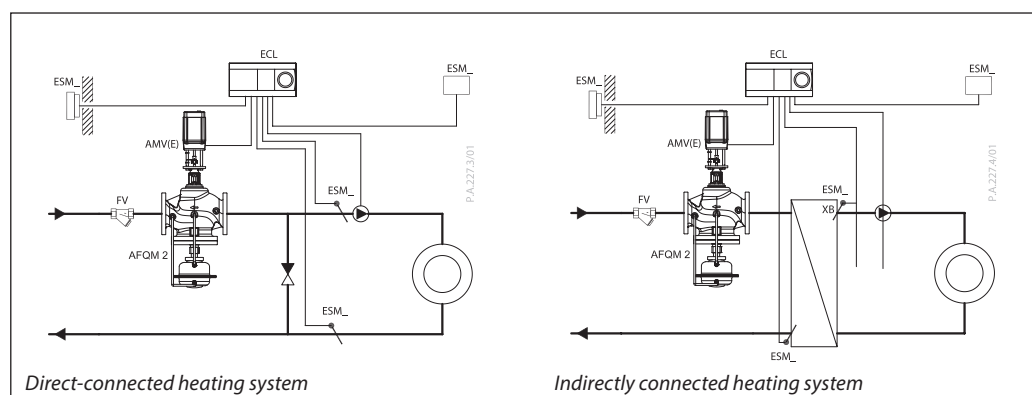

Installation positions

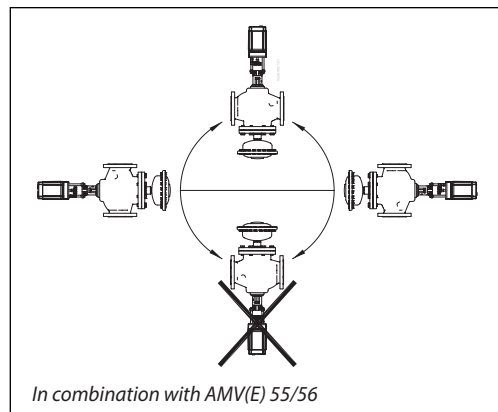
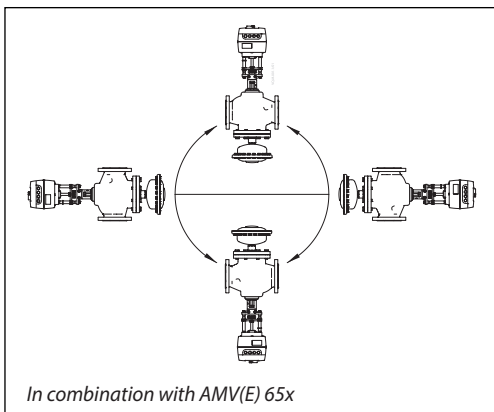

Note!

Installation positions for electrical actuators AMV(E) have to be observed as well. Please see relevant Data sheet.

Pressure temperature diagram

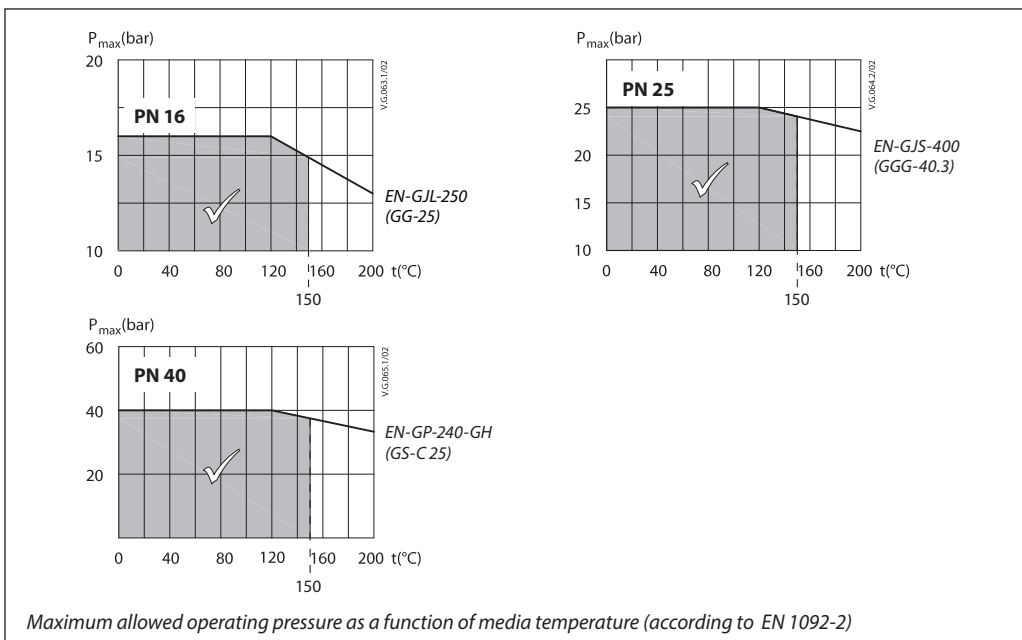

Design

1. Valve body
2. Flow control insert
3. Flow stuffing box
4. Max. flow limitation nut
5. Valve seat
6. Pressure control insert
7. Pressure actuator
8. Pressure actuator diaphragm
9. Pressure actuator spring
10. Diaphragm excess pressure safety valve
11. Flow control cone (CV)
12. Pressure control cone (DP)
13. Impulse tube
14. Union nut
15. Cover
16. Connection for electrical actuator
17. Pressure stuffing box

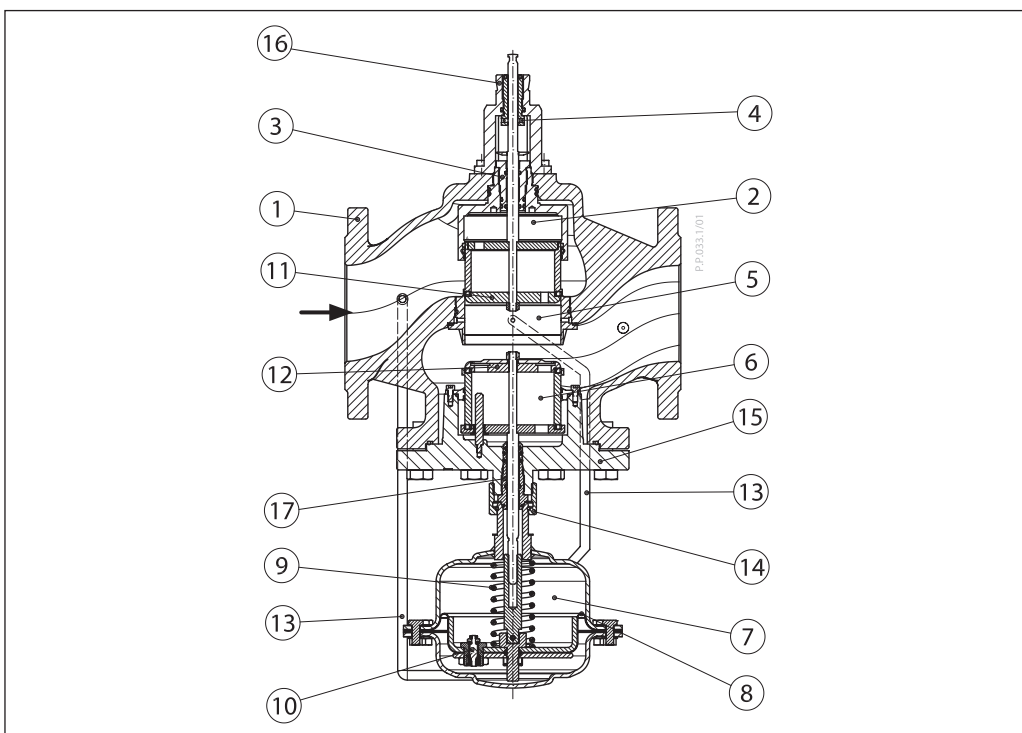

Settings

Flow setting

Flow limitation is being done by the adjustment of the max. flow limitation nut. The adjustment can be performed on the basis of flow limiting diagram (see relevant instructions) and/or by the means of heat meter.

Flow limiting curves in diagrams represent informational values, for more accurate flow limitation setting use flow/heat meter.

Flow limiting

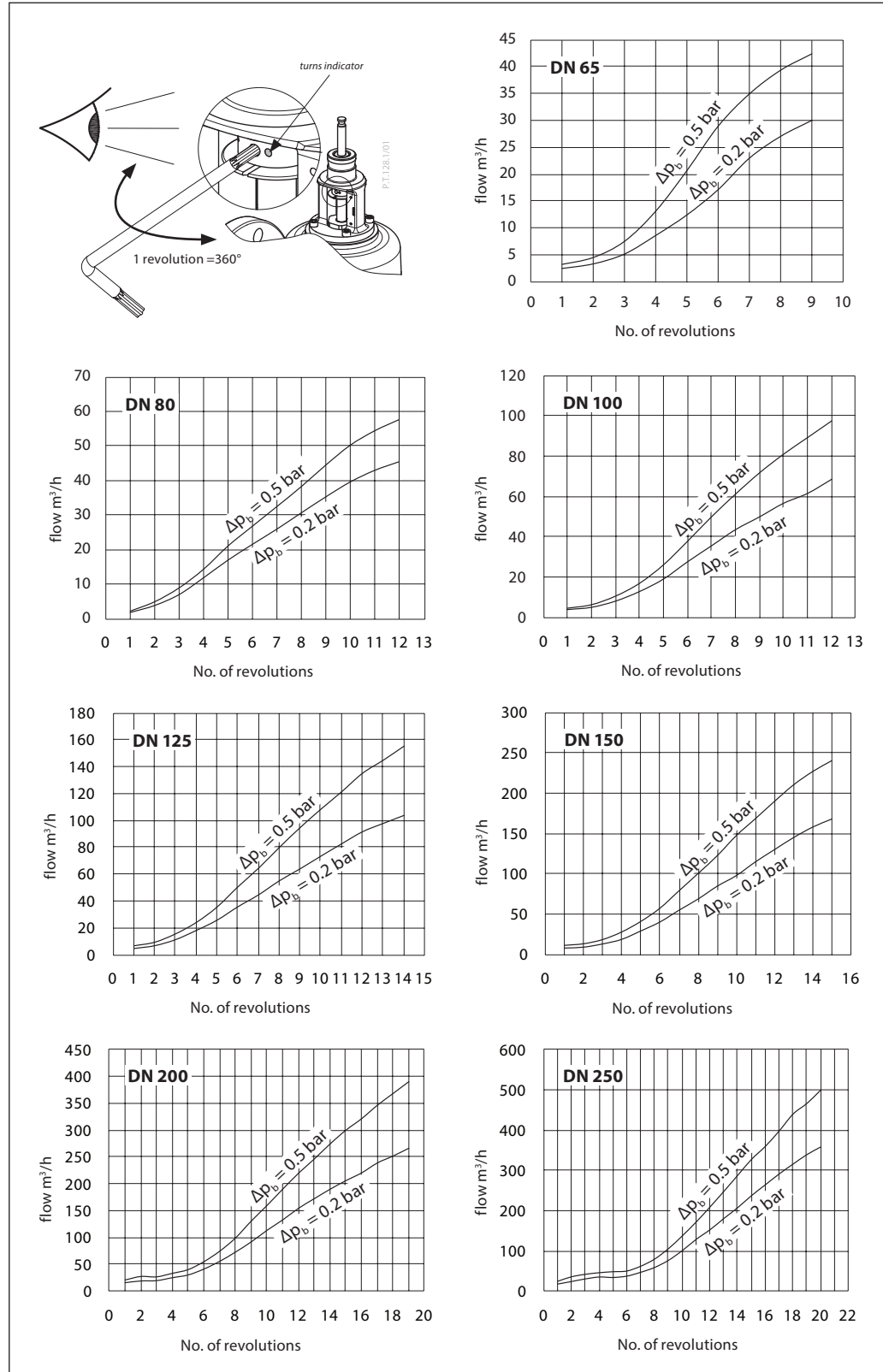

Function

Flow control cone adjusts the flow by opening and closing. This action is provided by an electric actuator. The max flow is limited by limiting the maximal opening of the flow control cone. This is done by rotating the flow limitation nut. The pressure independent flow control is achieved by maintaining a constant differential pressure over the flow control cone.

The differential pressure over the flow control cone is lead to the pressure actuator diaphragm through the impulse tubes. It is factory preset. The opening/closing of the pressure control cone is performed by changing differential pressure over the diaphragm.

When differential pressure over the flow control cone:

- a) rises, the pressure control cone takes over the exceeded differential pressure by closing, until set differential pressure over the flow control cone is reached.
- b) drops, the pressure control cone compensates the missing differential pressure by opening, until set differential pressure over the flow control cone is reached.

Pressure actuator diaphragm is equipped with excess pressure safety valve to protect diaphragm from the damages caused by too high differential pressure.

Dimensions

AMV(E) 55/AFQM 2 DN 65-250, PN 16/25/40
AMV(E) 56/AFQM 2 DN 65-125, PN 16/25/40

AMV(E) 65X/AFQM 2
DN 65-250, PN 16/25/40

DN	L	mm				Valve weight (kg)		
		H ₁ (PN16)	H ₁ (PN25/40)	H ₂	H ₃	PN 16	PN 25	PN 40
65	290	355	360	520	545	36	48	51
80	310	355	360	520	545	41	53	56
100	350	395	395	545	575	60	73	78
125	400	395	400	580	610	79	91	99
150	480	460	510	610	635	135	156	171
200	600	495	545	665	695	242	264	293
250	730	555	605	680	703	394	421	475



Danfoss A/S

Climate Solutions • danfoss.com • +45 7488 2222

Any information, including, but not limited to information on selection of product, its application or use, product design, weight, dimensions, capacity or any other technical data in product manuals, catalogues descriptions, advertisements, etc. and whether made available in writing, orally, electronically, online or via download, shall be considered informative, and is only binding if and to the extent, explicit reference is made in a quotation or order confirmation. Danfoss cannot accept any responsibility for possible errors in catalogues, brochures, videos and other material. Danfoss reserves the right to alter its products without notice. This also applies to products ordered but not delivered provided that such alterations can be made without changes to form, fit or function of the product.

All trademarks in this material are property of Danfoss A/S or Danfoss group companies. Danfoss and the Danfoss logo are trademarks of Danfoss A/S. All rights reserved.