

Installation guide

# Thermostat

## KP 61 – KP 85



060R9758

060R9758

**KP 61, KP 62, KP 63, KP 68, KP 69** vapour charge  
**KP 62, KP 71, KP 73, KP 75, KP 77, KP 78, KP 79, KP 81, KP 85** adsorption charge (cross ambient)

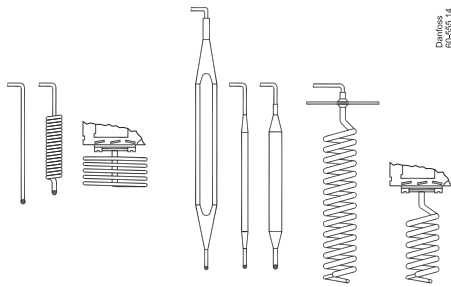
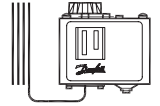

**Vapour charge    Adsorption charge**

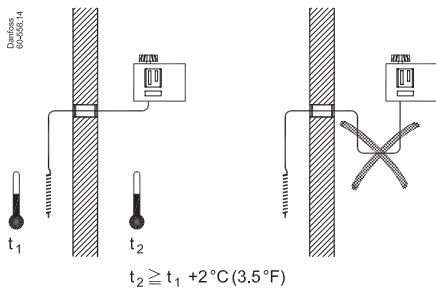
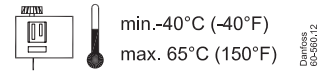
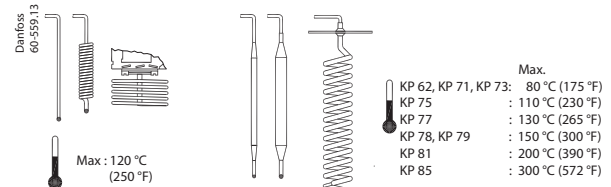

**Vapour charge**

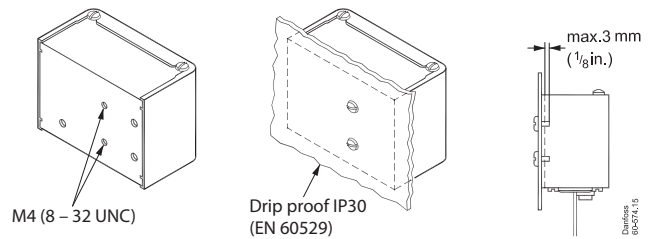
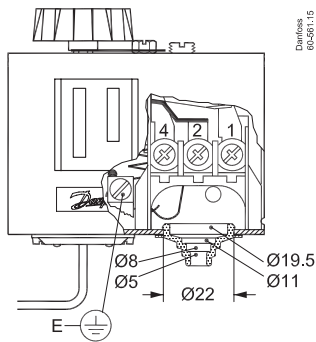
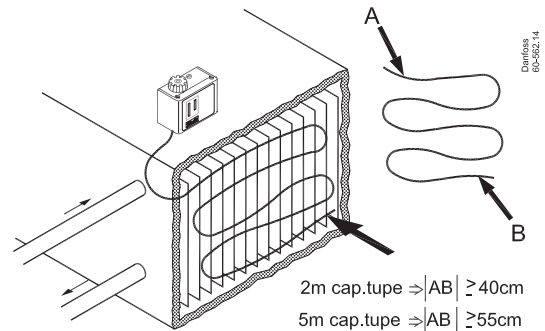

**Electrical rating - General**

LR 112A	AC 1: 16A	400 V	DC 11
	AC 3: 16A		12 W
	AC 15: 10 A		220 V

**When used acc. to UL regulations**

**UL US LISTED Listed refrigeration controller 61B5**

Voltage	FL	LR	Resist. load	Pilot duty
AC DC	A	A		
240	8	48	8 A	3 A
120	16	96	16 A	
	240			12 W

Use copper wire only  
 Tightening torque 20 lb.in.

\* not applying for KP 85

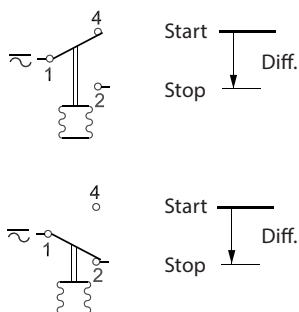

Імпортер: ТОВ з іі "Данфосс ТОВ" 04080, Київ 80, п/с 168, Україна

Info for UK customers only: Danfoss Ltd., 22 Wycombe End, HP9 1NB, GB



**CAUTION:**

Disconnect power supply before wiring connections are made or service to avoid possible electrical shock or damage to equipment.

Do never touch live parts with your fingers or with any tool.

**Manual trip function**

Automatic reset

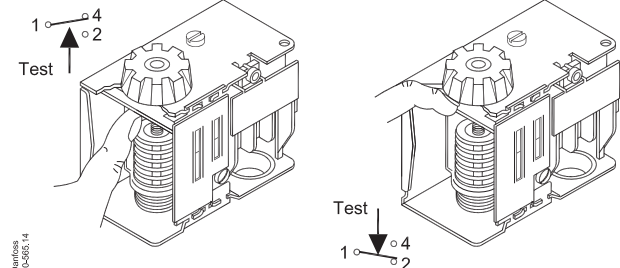

Danfoss  
60-433.14

Manual reset

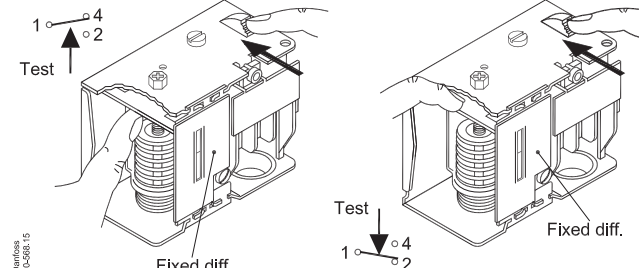

Danfoss  
60-285.15

<b>KP 61</b>	060L110466, 060L110566
<b>KP 71</b>	060L111566
<b>KP 73</b>	060L113866

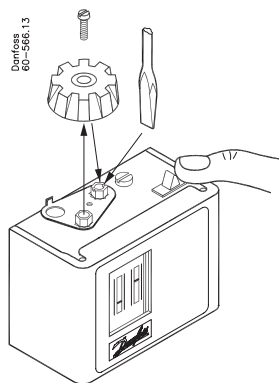

Danfoss  
60-566.13

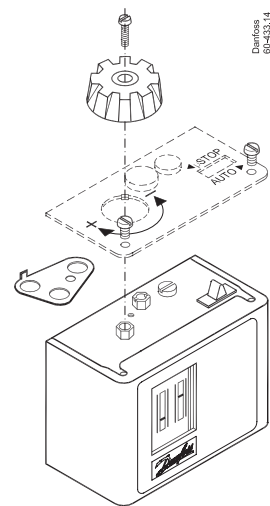

Danfoss  
60-433.14

**Vapour charge**

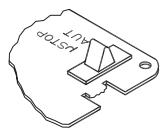
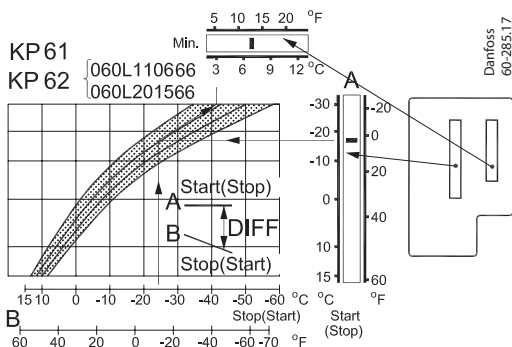

<b>KP 61</b>	060L110366 060L112866	Vapour charge
<b>KP 62</b>	060L111066	Adsorption charge
<b>KP 73</b>	060L111866	charge

