



Data Sheet

FH-ME Floor Heating Manifold

Application

The FH-ME Manifold is used for controlling water flow in under floor heating systems. Each tube of the floor heating system is connected to the manifold, thus making it possible to control water flow or heat supply to each room in the building individually.

The manifold consists of a supply and return manifold. The supply manifold includes possibility for individual shut-off of each circuit and as a flow adjustment. The return manifold is equipped with integrated Danfoss RA connection. The valves can be controlled electronically by thermal actuators or act as self-acting units by means of remote temperature adjusters.

The manifold is supplied in modules of 2 to 8 outlets. In addition extension pieces are available for connecting the manifolds in series. Ball valves are available as an option for positive shut-off between manifold and system. The end pieces FHF-EM and FHF-EA are supplied with manual airvent or alternatively with automatic airvent, purge and valve. The end pieces are placed at the end of the manifold.

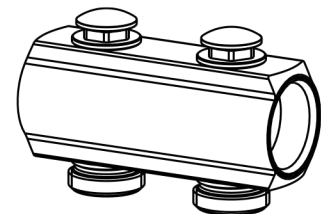

FH-ME supply

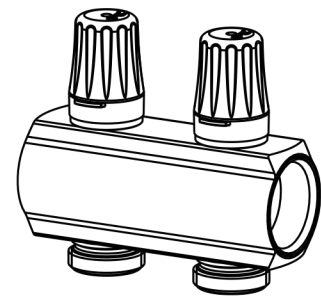

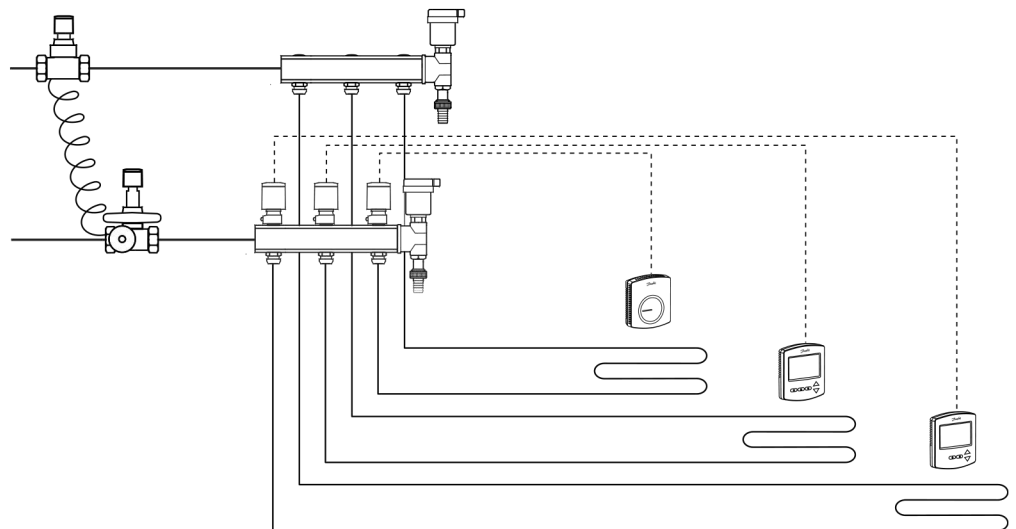

FH-ME return

System Layout





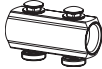







Data Sheet

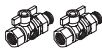

Ordering

| Description | Type | Code no. |
|--|--------|-----------------|
|  Manifold set 2+2 Manifold set 3+3 Manifold set 4+4 | FH-ME2 | 088U0612 |
| | FH-ME3 | 088U0613 |
| | FH-ME4 | 088U0614 |
|  Manifold set 5+5 Manifold set 6+6 Manifold set 7+7 Manifold set 8+8 | FH-ME5 | 088U0615 |
| | FH-ME6 | 088U0616 |
| | FH-ME7 | 088U0617 |
| | FH-ME8 | 088U0618 |

Accessories

| Description | Type | Code no. |
|--|--------|-----------------|
|  End section - automatic airvent and purge valve | FHF-EA | 088U0580 |
|  End section - manual airvent and purge valve | FHF-EM | 088U0581 |
|  End caps - set | FHF-E | 088U0582 |
|  Connection pieces - set | FHF-C | 088U0583 |
|  Reduction bushes/pieces - set 1" - 3/4" | FHF-R | 088U0584 |
|  Mounting brackets - set | FHF-MB | 088U0585 |
|  2 x ball valve 1" with tail piece - for connection to manifold and for blocking of floor heating system | FHF-BV | 088U0586 |
|  1 x thermometer 0-60°C Ø35mm - for flow/return temperature measurement | FHF-T | 088U0029 |
|  Thermal actuator, 24 V, NC, Danfoss RA connection to valve | TWA-A | 088H3110 |
|  Thermal actuator, 230 V, NC, Danfoss RA connection to valve | TWA-A | 088H3112 |
|  Thermal actuator, 24 V, NC, with end switch, Danfoss RA connection to valve | TWA-A | 088H3114 |

Compression Fittings

| Description | Type | Code no. |
|--|------------|-----------------|
|  Compression fittings for PEX tubing in accordance with ISO 15875. • Max working pressure: 6 bar • Test pressure: 10 bar • Max. flow temperature: 95 °C • G 3/4" internal thread | 16x2 mm | 013G4156 |
| | 20x2 mm | 013G4160 |
| | 20x2.25 mm | 013G4093 |
| | 20x2.5 mm | 013G4161 |
|  Compression fittings for ALUPEX tubing. • Max working pressure: 6 bar • Test pressure: 10 bar • Max. flow temperature: 95 °C • G 3/4" internal thread | 16x2 mm | 013G4186 |
| | 20x2 mm | 013G4190 |
| | 20x2.25 mm | 013G4093 |
| | 20x2.5 mm | 013G4191 |
|  Compression fittings for STEEL and COPPER tubing • Max working pressure: 6 bar • Test pressure: 10 bar • Max. flow temperature: 95 °C • G 3/4" internal thread | 16 mm | 013G4126 |
| | 18 mm | 013G4128 |

Note: Max flow temperature given by the tube manufacturer must not be exceeded.

Data Sheet

Commissioning

The pre-setting of the manifold valves determines the flow in the floor heating tubes and is therefore an important factor for obtaining optimal hydraulic balance in the system.

A correct hydraulic balance is important if optimal comfort shall be achieved with a minimum of energy consumption and is easily carried out following the example shown below.

Example

| | | |
|---------|---|---|
| Room 1: | 1. Determine longest tube/largest room | 25 m ² |
| | 2. Desired cooling (ΔT) | 5° C (typical) |
| | 3. Determine heat requirement for the room | 50 W/m ² |
| | 4. Conversion factor | 1.16 |
| | 5. Calculation of flow for the room | $Q \text{ (l/h)} = \frac{50 \text{ W/m}^2 \times 25 \text{ m}^2}{10^\circ \text{ C} \times 1.16} = 108 \text{ l/h}$ |
| Room 2: | 6. Determine area for the next room | 15 m ² |
| | 7. Calculation of flow for the room (ΔT and heat requirement is assumed identical for the rooms in this case) | $Q \text{ (l/h)} = \frac{50 \text{ W/m}^2 \times 15 \text{ m}^2}{10^\circ \text{ C} \times 1.16} = 65 \text{ l/h}$ |

Capacity

The diagram shows the capacities of each heating circuit for different settings of the flow manifold.

The figures 3/4 to 4 above the diagram indicate how many turns of the key are required to obtain the correct water volume (count from closed position onwards).

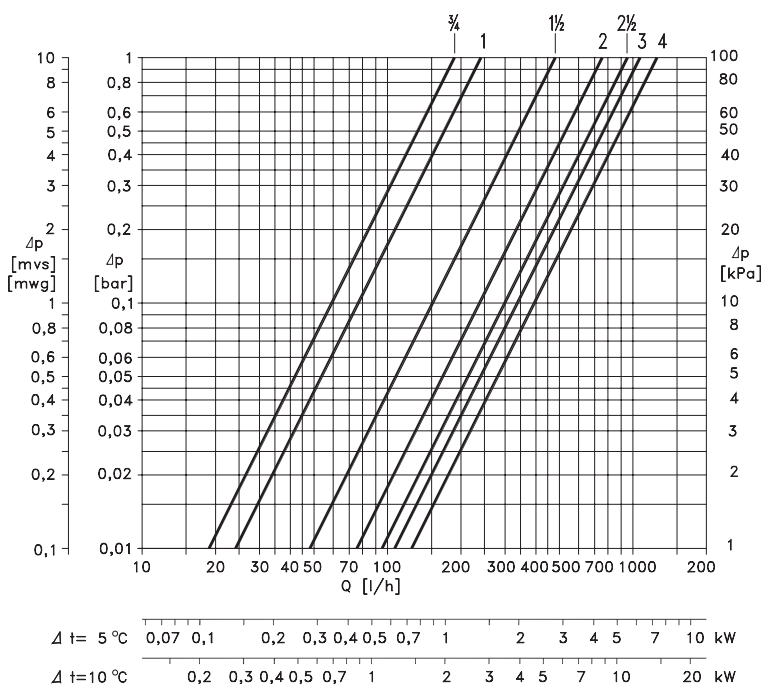
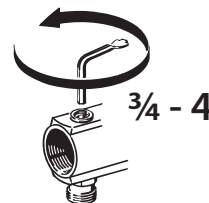

Operation Conditions

Max. differential pressure..... 0.6 bar
 Max. working pressure 10 bar
 Max. test pressure 16 bar
 Max. flow temperature 90° C

Dimensions

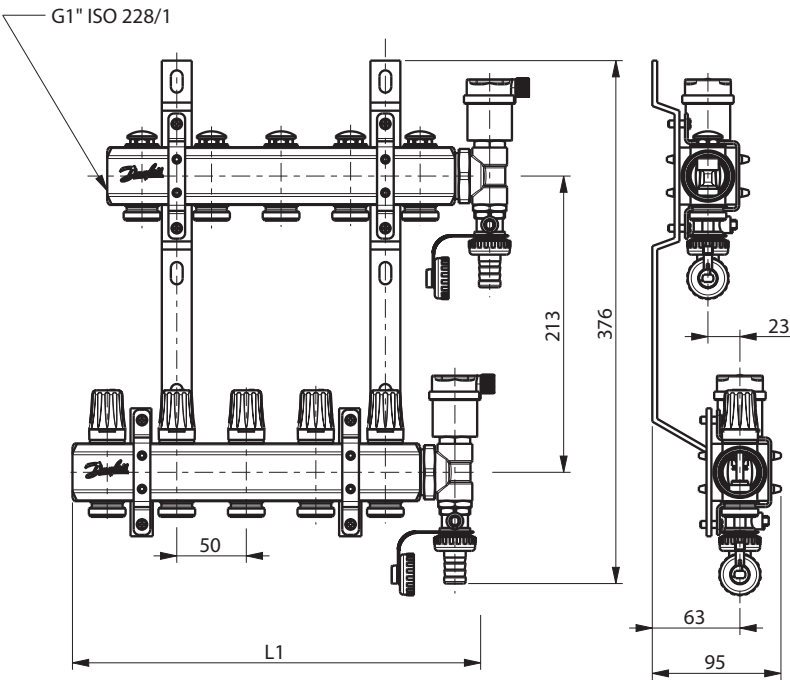

| Type | 2+2 | 3+3 | 4+4 | 5+5 | 6+6 | 7+7 | 8+8 |
|---------|-----|-----|-----|-----|-----|-----|-----|
| L1 (mm) | 143 | 193 | 243 | 293 | 343 | 393 | 443 |

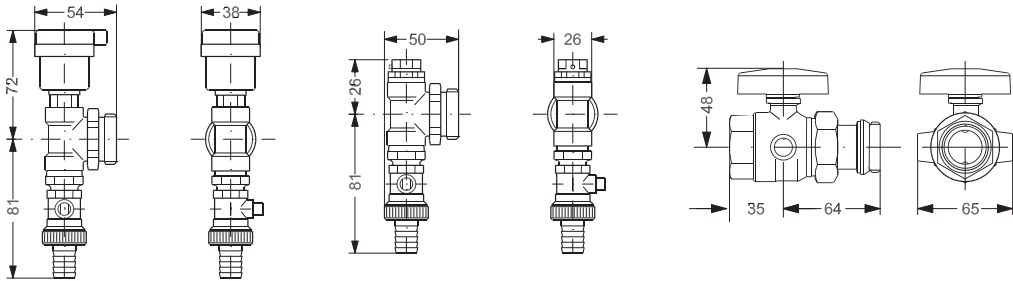

Danfoss A/S

Floor Heating Hydronics • Ulvehavevej 61 • DK-7100 Vejle • Denmark • Phone: +45 7488 8500 • Fax: +45 7488 8501
 heating@danfoss.com • www.floorheating.danfoss.com

Danfoss can accept no responsibility for possible errors in catalogues, brochures and other printed material. Danfoss reserves the right to alter its products without notice. This also applies to products already on order provided that such alterations can be made without subsequential changes being necessary in specifications already agreed. All trademarks in this material are property of the respective companies. Danfoss and the Danfoss logotype are trademarks of Danfoss A/S. All rights reserved.